

UPS

UNINTERRUPTIBLE POWER SUPPLY

up to 4.8 MVA



GLOBAL SPECIALIST IN ELECTRICAL
AND DIGITAL BUILDING INFRASTRUCTURES



UPS systems: UPS units up to

SINGLE-PHASE UPS

Keor LP



Single-phase UPS, on-line double conversion VFI-SS-111 from 1 to 3 kVA

P. 12

Daker DK Plus



Single-phase UPS, on-line double conversion VFI from 1 to 10 kVA

P. 14

Keor S



Single-phase UPS, on-line double conversion VFI from 3 to 10 kVA

P. 18

MODULAR UPS

Megaline



Single-phase UPS, on-line double conversion VFI from 1.25 to 10 kVA

P. 25

Trimod HE



Three-phase UPS, on-line double conversion VFI from 10 to 80 kVA

P. 29

Trimod MCS



Modular CPS, on-line double conversion VFI from 3 to 80 kVA

P. 32

CONVENTIONAL UPS

Keor Compact



Three-phase UPS, on-line double conversion VFI from 10 to 20 kVA

P. 40

Keor T Evo



Three-phase UPS, on-line double conversion VFI from 10 to 60 kVA

P. 42

Keor HP



Three-phase UPS, on-line double conversion VFI from 100 to 800 kVA

P. 44

BATTERY CABINET



Universal battery cabinets for all three-phase UPS from 10 to 800 kVA.

P. 50

4.8 MVA

Keor MOD



Three-phase UPS, on-line double conversion VFI from 25 to 250 kVA

[P. 34](#)

Keor HPE



Three-phase UPS, on-line double conversion VFI from 60 to 500 kVA

[P. 46](#)

Keor XPE



Three-phase UPS, on-line double conversion VFI from 600 to 2100 kVA

[P.48](#)

COMMUNICATION ACCESSORIES AND SOFTWARE

Network interfaces



[P. 53](#)

Network interface accessories



[P. 54](#)

Software



[P. 55](#)



UPS

High performance, uninterruptible service and energy efficiency.

The wide diffusion of UPS systems generally stems from an increasing dependence on electricity and the need to protect a range of equipment, data and processes that are crucial to companies. Power electronics is focused on the design and development of static UPS with increasing performance, which provide adequate energy saving along with lower environmental impact.

Safety and uninterruptible service

Any electronic device that is not properly protected by UPS systems may be subject to disturbances from the mains supply. Electrical events such as voltage dips, black-outs, voltage surges, or other voltage or frequency anomalies, can generate serious consequences including:

- interruption of services
- loss of data and information
- faults or damage to the actual electronic devices.

The solution to these problems is provided by Uninterruptible Power Supplies (UPS) which, when installed between the power supply network and the equipment, **improve the quality of the power** by ensuring **uninterruptible service** and **protection** of all devices that perform functions that are critical to the business life of companies.

Energy efficiency

Thanks to the use of the latest technologies, the new concept UPS boast high efficiency and an intelligent battery charging system that extends its useful life. In addition to significantly reducing UPS consumptions and operating costs, these features contribute to reducing the environmental impact of battery disposal.





LEGRAND IS A WORLD LEADER IN THE MANUFACTURING OF ELECTRICAL EQUIPMENT,

and offers a wide range of solutions for the tertiary sector, that meet all system demands, from cabling systems for data networks, to channelling and distribution systems, to plant control and management.

Today, with a view to technological development that respects the environment and in order to face a constantly evolving market, Legrand proposes a new UPS range, a complementary offer of technological functions able to guarantee maximum protection for all systems.

Legrand UPS is currently the manufacturer with the highest growth rate on the market; it also recently received two major awards worldwide and was named Company of the Year and Company with the highest growth rate by Frost & Sullivan (an international market research and consulting firm).

These results have been achieved through a number of factors such as recent acquisitions, product development activity and, above all, growth in sales of products and services.



SUSTAINABILITY

Corporate Social Responsibility

Green management and sustainable supply chain: these concepts are part of Legrand's Corporate Social Responsibility, which is the company's commitment to drawing up a strategy and implementing it with practical actions aimed at socially responsible behaviour towards everything around it, such as people, things and environment.

CSR involves the management of human resources, the organization and division of labour and the management of natural resources. CSR aims to assess the impact that the company's actions and decisions have internally, but also externally, on the stakeholders and the environment.

Circular economy

We are committed to creating a system that involves all stakeholders to share values, objectives and actions in order to control and reduce the environmental impact of all our economic and production processes, reduce waste and environmental impact and transform what would once have been defined as «waste» into new resources.

Controlling these aspects has an impact on the entire life cycle of the product, starting from the design of new concepts and new specifications for the materials the UPS is made of; this is possible through responsible design and procurement processes (so-called «green procurement»), with a strong focus on research and the use of innovative materials from the circular economy and alternative raw materials. When a product ends its life, all these materials can become high value-added resources that can be used in other production cycles.

Digitalization

New information technologies allow us to reduce the use of several paper documents in favor of the digital format: in this way the information is always and everywhere accessible from a PC or smartphone and at the same time we can avoid the felling of many trees.

Digitization also becomes an important driver of the circular economy, since it allows the use of tools for performance data analysis and preventive diagnostics, both useful for optimizing the life cycle and durability of the product.





BUSINESS ECOSYSTEM

or how Legrand interacts ethically with the whole ecosystem of its activities.

PEOPLE

or how Legrand engages with all of its employees and stakeholders.

ENVIRONMENT

or how Legrand intends to limit the Group's environmental impact.



Efficiency

Our R&D team is constantly working on the development of increasingly efficient UPSs that allow high and incremental performance with minimum energy dissipation; with regard to CO₂ emissions, we are implementing processes and products that represent an improvement in the percentage of carbon footprint compared to the past. But efficiency is not only synonymous with high performance. For us, efficiency also means ecodesign: this implies that the UPS is designed to be easily repaired, maintained and it's easy to separate its components. This means increasing the durability of our UPSs and the possibility of reusing and recycling them at the end of their life.

L'EPD/PEP

For each product range we draw up an EPD (Environmental Product Declaration) or PEP (Profil Environnemental Produit) in line with ISO 14025: it is a declaration that is a sort of environmental photograph of the product. The EPD is drawn up according to the concept of Life Cycle Assessment: it examines the environmental impact of a product throughout its life cycle, from the development of product specifications to the choice of materials to be used and the end-of-life destination of the product itself.





LEGRAND UPS

Distinguishing characteristics

High performance

The innovative design and high quality of the components used enable our UPS to achieve up to 96,5% efficiency, leading to significant energy savings.

Latest generation components

In-depth research on the best electronic components on the market combined with state-of-the-art manufacturing methods, make Legrand UPS extremely reliable and abreast of the times.

Environmentally sustainable products

Efficient UPS built with maximum attention to detail. Moreover, Legrand has developed an innovative testing system which reduces the energy consumed for each device manufactured.

Advanced technology

The On-line Double Conversion technology ensures a top quality power supply and maximum energy efficiency.

Reliable electronics

The optimum sizing of the power stages and thorough testing of each unit ensure excellent reliability.

High performance batteries

The batteries supplied with Legrand UPS are the best on the market. The innovative charging system significantly extends the life of the battery by up to 50%.

Services

Legrand provides a complete range of services to meet the demands of all its customers



Range of **application**

Each type of UPS is characterised by different design properties, which means that the range is ideally suitable and usable in different environments, from domestic to tertiary and industrial sectors, and applications in specific fields.

DOMESTIC APPLICATIONS

Video surveillance, home alarms, smart TV, Home Entertainment systems

TRADE AND TERTIARY SECTORS

Offices, shops, points of sale

HEALTH AND HOSPITALITY SECTORS

Hospitals, medical centres, hotels

INDUSTRIAL AND LARGE TERTIARY STRUCTURE SECTORS

Factories, warehouses, shopping centres

TRANSPORT

Airports, rail and ship transport

DATA PROCESSING CENTRES

Datacenter



RANGE

LEGRAND offers a range of UPS products that are divided into 2 different types of products:
single-phase and three-phase.

The range is wide and complete, with solutions that guarantee maximum performance in terms of power and backup time.



Megaline -
Megaline Rack



Keor LP



Daker DK Plus



Keor S

Online

Single-phase UPS



Keor MOD



Trimod HE



Trimod MCS

Modular

Three-phase UPS



Keor Compact



Keor HP



Keor T Evo



Keor HPE



Keor XPE

Conventional



Keor LP

Conventional UPS - Single phase On-line double conversion VFI



3 101 54

3 101 56

3 101 58

Characteristics:

- Single-phase UPS
- Power from 1 to 3 kVA
- VFI-SS-111 on-line double conversion
- RS232 communication port
- LAN / SNMP connectivity
- Uptime can be extended with additional battery cabinets
- Compact design and low footprint

Item	UPS with IEC sockets					
	Nominal power (VA)	Active power (W)	Backup time (min)	No. of sockets IEC 10A	No. of french socket	Weight (kg)
3 101 54	1000	900	5	3	-	10
3 101 56	2000	1800	5	6	-	17
3 101 58	3000	2700	5	6	-	23

Item	UPS with french standard sockets					
	Nominal power (VA)	Active power (W)	Backup time (min)	No. of sockets IEC 10A	No. of french socket	Weight (kg)
3 101 55	1000	900	5	3	1	10
3 101 57	2000	1800	5	3	2	17
3 101 59	3000	2700	5	6	2	23

Accessories

Description

3 105 98*	Additional battery cabinet for 3 101 54 - 3 101 55
3 105 99*	Additional battery cabinet for 3 101 56 - 3 101 57
3 106 00*	Additional battery cabinet for 3 101 58 - 3 101 59
3 109 58	Additional battery charger for battery cabinet 3 105 98
3 109 60	Additional battery charger for battery cabinet 3 105 99
3 109 61	Additional battery charger for battery cabinet 3 106 00
3 109 53	Bypass
3 110 78	10 A british standard cable for 3 101 54 - 3 101 55 - 3 101 56 - 3 101 57
3 110 79	16 A british standard cable for 3 101 58 - 3 101 59

*Battery included

NOTE: the stated backup times in minutes are estimated and may vary according to the load characteristics, operating conditions and environment.

n Keor LP 1000

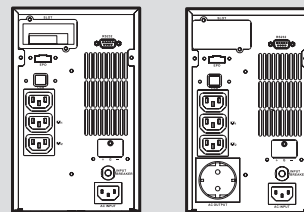

n Keor LP 2000

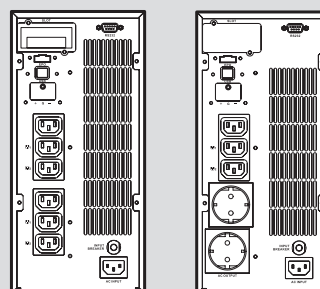

n Keor LP 3000

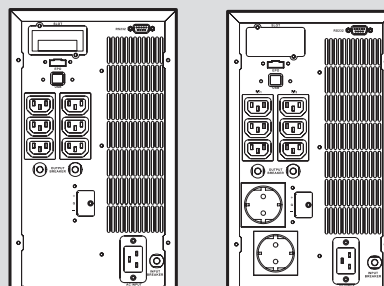

Keor LP

Conventional UPS - Single phase On-line double conversion VFI

n Characteristics

General characteristics	3 101 54 3 101 55	3 101 56 3 101 57	3 101 58 3 101 59
Nominal power (VA)	1000	2000	3000
Active power (W)	900	1800	2700
Technology	On-line double conversion VFI-SS-111		
Waveform	Sinusoidal		
Architecture	UPS with extendable Backup time		
Input characteristics			
Input voltage	230 V		
Input frequency	45-65 Hz ± 2 % Autosensing		
Input voltage range	210 V \div 240 Vac at 100% load		
Input power factor	$> 0,99$		
Output characteristics			
Output voltage	230 V ± 1 %		
Efficiency	Up to 90 %		
Output frequency (nominal)	50/60 Hz synchronised		
Peak factor	3 : 1		
THD of output voltage	< 3 % with linear load		
Overload capacity:	< 105 % ONLINE mode, 121 \div 150% for 10 sec., 106 \div 120% for 30 sec., > 151 % instant transfer to bypass		
Bypass	Automatic, internal, synchronised, electromechanical (for overloads and operating problems)		
Batteries			
Backup time extension	Si		
Backup time (min)	5		
Communication and management			
Screen and signalling	Multi-coloured LED status indicator, alarms and audible signalling		
Communication ports	1 RS232 serial port, 1 slot for network interface connection (ex. CS141)		
Emergency Power Off (EPO)	Yes		
Remote control	Software can be downloaded free of charge		
Mechanical characteristics			
Dimensions (H x W x D) (mm)	236 x 144 x 367	322 x 151 x 444	322 x 189 x 444
Dimensions of battery cabinet (H x W x D) (mm)	322 x 151 x 444	322 x 151 x 444	322 x 151 x 444
Battery cabinet Net weight (kg)	31	31	31
Ambient conditions			
Ambient operating temperature (°C)	0 - 40		
Relative humidity (%)	20 - 80 non condensing		
Noise at 1 m (dBA)	< 50		
Certifications			
Reference product standards	EN 62040-1, EN 62040-2, EN 62040-3		

Daker DK Plus

Dual conversion online UPS (rack/tower) - single phase VFI



3 101 76



3 101 77



3 101 76 rack version

Characteristics:

- Conventional single-phase UPS
- Power from 1 to 10 kVA
- 0.9 power factor for 1000-3000, 1 for 5000-10000
- On-Line double conversion VFI-111
- User-friendly display
- Additional battery compartment to extend backup time
- Intelligent battery management
- Operator-friendly replaceable battery
- Display of battery status, system parameters, battery charge level and faults.

- Dedicated slot to connect one of the following two optional accessories: network interface (WEB/SNMP) or relay interface capable of providing isolated contacts for applications on industrial panels or remote alarm panels.
- Automatic bypass (and manual, optional) to guarantee uninterruptible power supply to critical loads, in the event of electronic failure, overload, overheating or scheduled maintenance.
- Maintenance bypass switch box (MTBS).

Item	Convertible UPS with batteries			
	Nominal power (VA)	Active power (W)	Backup time (min)	Weight (kg)
3 101 70	1000	900	9	16
3 101 71	2000	1800	10	29.5
3 101 72	3000	2700	7	30
3 101 73	5000	5000	6	60
3 101 74	6000	6000	5	60

Item	Convertible UPS without batteries			
	Nominal power (VA)	Active power (W)	Phase configuration	Weight (kg)
3 101 75	5000	5000	1/1	25
3 101 76	6000	6000	1/1	25
3 101 77	10000	10000	1/1	26
3 101 78*	10000	9000	3/1	28

* three-phase input - single-phase output version

Item	Battery cabinet with batteries
3 106 60	Battery cabinet for 3 101 70
3 106 61	Battery cabinet for 3 101 71
3 106 62	Battery cabinet for 3 101 72
3 106 63	Battery cabinet for 3 101 73 - 3 101 74 - 3 101 75 - 3 101 77
3 106 64	Battery cabinet for 3 101 77 - 101 78

NOTE: the stated backup times in minutes are estimated and may vary according to the load characteristics, operating conditions and environment.



Item	Empty battery cabinet
3 106 65	Battery cabinet for 3 101 70
3 106 66	Battery cabinet for 3 101 71
3 106 67	Battery cabinet for 3 101 72
3 106 68	Battery cabinet for 3 101 73 - 3 101 74 - 3 101 75 - 3 101 76
3 106 69	Battery cabinet for 3 101 77 - 101 78

Item	Accessories
3 109 52	Rack support bracket kit
3 109 53	External manual bypass for 3 101 70 - 3 101 71 - 3 101 72
3 109 63	External manual bypass for 3 101 73 - 3 101 74 - 3 101 75 - 3 101 76 - 3 101 77
3 109 69	Dry contact card
3 109 59	Additional charger for 3 101 70
3 109 61	Additional charger for 3 101 71 - 3 101 72
3 109 54	Additional charger for 3 101 73 - 3 101 74 - 3 101 75 - 3 101 76 - 3 101 77 - 3 101 78
3 110 78	10 A british standard cable for 3 101 70 - 3 101 71
3 110 79	16 A british standard cable for 3 101 72

Daker DK Plus

UPS - double conversion online VFI

Characteristics

General characteristics	3 101 70	3 101 71	3 101 72	3 101 73	3 101 75	3 101 74	3 101 76	3 101 77	3 101 78
Nominal power (VA)	1000	2000	3000	5000		6000		10000	10000
Active power (W)	900	1800	2700	5000		6000		10000	9000
Technology	On-Line Double Conversion VFI-SS-111								
Waveform	Sinusoidal								
UPS Architecture	convertible tower and rack 19								
Input									
Input voltage	230 V								380V 3F+N
Input frequency	50-60 Hz \pm 5% Autosensing								
Input voltage range	180 - 300 Va.c. at full load			170 - 280 Va.c. at full load				305 - 485 Va.c. at full load	
THD Input current	< 3%								
Input power factor	> 0.99								> 0.9
Output									
Output voltage	230V \pm 1%								
Nominal output frequency	50/60 Hz (LCD screen settings) +/- 0,1%								
Efficiency	Up to 90%	Up to 91%	Up to 92%	Up to 94%				Up to 90%	
Crest factor	3:1								
THD Output Voltage	< 3% with linear load								
Output Voltage Tolerance	\pm 1%								
Internal automatic bypass	Included								
External maintenance bypass	optional	optional	optional	-	-	-	-	-	-
Batteries									
Backup time extension	Yes								
Communication and Management									
Screen and signalling	LCD display with three buttons and five LEDs to monitor UPS status and main operating parameters in real time								
Communication ports	RS232, USB								RS232
Remote control	Available								
Network interface slot	Yes								
Backfeed protection	Yes								
Remote emergency power Off (EPO)	Yes								
Mechanical Characteristics									
Dimensions HxWxD (mm)	440 x 88 (2U) x 405	440 x 88 (2U) x 600		440x196 (4U)x680	440x88 (2U)x680	440x196 (4U)x680	440x88 (2U)x680	440x132 (3U) x680	
Net weight (kg)	16	29.5	30	60	25	60	25	26	28
Battery cabinet dimensions HxWxD (mm)	440x196 (4U)x425	440 x 88 (2U) x 600		-	440 x 88 (2U) x 680	-	440 x 88 (2U) x 680	440 x 132 (3U) x 680	
Ambient Conditions									
Operating temperature (°C)	0 - 40								
Protection rating	IP20								
Relative humidity (%)	< 95% (non condensing)								
Noise at 1 m from the unit (dBA)	< 50								
Heat Dissipation (BTU/h)	490	654	818	982	1300		1636		
Estimated content of circular economy derived materials	37%								
Recyclability rate calculated using the method described in technical report IEC/TR 62635*	74%								
Conformity									
Certifications	EN 62040-1, EN 62040-2, EN 62040-3								
Warranty									
Standard warranty	EXCHANGE 2 year formula								

NOTE: The stated backup times in minutes are estimated and may vary according to the load characteristics, operating conditions and environment

*This value is based on data collected from a technological channel operating on an industrial basis. It does not pre-validate the effective use of this channel for end-of-life of this product.

Daker DK Plus

UPS - On-line double conversion VFI, 120V



3 101 40

Item	Convertible 120V UPS with batteries (UL)			
	Nominal power (VA)	Active power (W)	Backup time (min)	Weight (kg)
3 101 40	1000	900	up to 15	11
3 101 41	1500	1350	up to 15	14,5
3 101 42	2000	1800	up to 15	20
3 101 43	3000	2700	up to 15	27

Battery cabinet with batteries (UL)

Item	Description
3 101 44	Battery cabinet for 3 101 40 (UL)
3 101 45	Battery cabinet for 3 101 41 (UL)
3 101 46	Battery cabinet for 3 101 42 (UL)
3 101 47	Battery cabinet for 3 101 43 (UL)

Accessories

Item	Description
3 109 52	Rack support bracket kit
3 109 69	Dry contact card

NOTE: the stated backup times in minutes are estimated and may vary according to the load characteristics, operating conditions and environment.

Characteristics

General characteristics	3 101 40	3 101 41	3 101 42	3 101 43
Nominal power (VA)	1000	1500	2000	3000
Active power (W)	900	1350	1800	2700
Technology	On-line double conversion VFI-SS-111			
Waveform	Sinusoidal			
Architecture	Convertible tower and 19" rack			
Input characteristics				
Input voltage	120 V			
Input frequency	50-60 Hz ± 5% autosensing			
Input voltage range	90V - 150V at full load			
THD of input current	< 3%			
Input power factor	> 0,99			
Input connection	NEMA 5-15P	NEMA 5-20P	NEMA L5-30P	
Output characteristics				
Output voltage	120 V ±1%, adjustable to 100/110/115/120			
Output frequency (nominal)	50/60 Hz (configurable via LCD panel) +/- 0.1%			
Efficiency	up to 92%			
Peak factor	3:1			
THD of output voltage	< 3% with linear load			
Output voltage tolerance	± 1%			
Output Connection	6*NEMA 5-15R	6*NEMA 5-20P	6*NEMA 5-20P 1*NEMA L5-30P	
Internal automatic bypass	included			
Batteries				
Backup time extension	Yes			
Battery nominal voltage (Vdc)	24	36	48	72
Communication and management				
Screen and signalling	Four buttons and five LEDs for real-time control			
Communication ports	RS232 and USB serial ports			
Remote control	Available			
Connector for network interface	SNMP			
Back feed protection	yes			
Emergency power off (EPO)	yes			
Mechanical characteristics				
Dimensions (H x W x D) (mm)	440 x 88 (2U) x 405	440 x 88 (2U) x 485	440 x 88 (2U) x 600	
Net weight (kg)	11	14,5	20	27
Dimensions of battery cabinet H x W x D (mm)	40 x 88 (2U) x 600			
Ambient conditions				
Operating temperature (°C)	0 - 40°C			
Protection index	IP 20			
Relative humidity (%)	0-90% (without condensation)			
Noise at 1 m (dBA)	< 50			
Certifications				
Reference product standards	UL1778 V4 (cTUVus), FCC Part 15 Class A			

Daker DK Plus

Long backup times table

Model	Power	Back-up time	No. cabinets and dimensions HxWxD (mm)	Codes
Daker DK Plus	1000 VA	9'	440 x 88 x 405	3 101 70
		1h 27'	440 x 88 x 405 + 440 x 196 x 425	3 101 70 + 3 106 60
		3h	440 x 88 x 405 + 440 x 196 x 425 (x2)	3 101 70 + 3 106 60 (x2)
	2000 VA	10'	440 x 88 x 600	3 101 71
		45'	440 x 88 x 600 (x2)	3 101 71 + 3 106 61
		1h 28'	440 x 88 x 600 (x3)	3 101 71 + 3 106 61 (x2)
	3000 VA	7'	440 x 88 x 600	3 101 72
		31'	440 x 88 x 600 (x2)	3 101 72 + 3 106 62
		58'	440 x 88 x 600 (x3)	3 101 72 + 3 106 62 (x2)
		1h 29'	440 x 88 x 600 (x4)	3 101 72 + 3 106 62 (x3)
	5000 VA	6'	440 x 88 x 680 + 440 x 88 x 680	3 101 75 + 3 106 63
		19'	440 x 88 x 680 + 440 x 88 x 680 (x2)	3 101 75 + 3 106 63 (x2)
		32'	440 x 88 x 680 + 440 x 88 x 680 (x3)	3 101 75 + 3 106 63 (x3)
		50'	440 x 88 x 680 + 440 x 88 x 680 (x4)	3 101 75 + 3 106 63 (x4)
	6000 VA	5'	440 x 88 x 680 + 440 x 88 x 680	3 101 76 + 3 106 63
		15'	440 x 88 x 680 + 440 x 88 x 680 (x2)	3 101 76 + 3 106 63 (x2)
		30'	440 x 88 x 680 + 440 x 88 x 680 (x3)	3 101 76 + 3 106 63 (x3)
		45'	440 x 88 x 680 + 440 x 88 x 680 (x4)	3 101 76 + 3 106 63 (x4)
	10000 VA	6'	440 x 132 x 680 + 440 x 132 x 680	3 101 77 + 3 106 64
		17'	440 x 132 x 680 + 440 x 132 x 680 (x2)	3 101 77 + 3 106 64 (x2)
28'		440 x 132 x 680 + 440 x 132 x 680 (x3)	3 101 77 + 3 106 64 (x3)	
41'		440 x 132 x 680 + 440 x 132 x 680 (x4)	3 101 77 + 3 106 64 (x4)	
54'		440 x 132 x 680 + 440 x 132 x 680 (x5)	3 101 77 + 3 106 64 (x5)	
Daker DK plus 3 - 1	10000 VA	7'	440 x 132 x 680 + 440 x 132 x 680	3 101 78 + 3 106 64
		19'	440 x 132 x 680 + 440 x 132 x 680 (x2)	3 101 78 + 3 106 64 (x2)
		31'	440 x 132 x 680 + 440 x 132 x 680 (x3)	3 101 78 + 3 106 64 (x3)
		45'	440 x 132 x 680 + 440 x 132 x 680 (x4)	3 101 78 + 3 106 64 (x4)
		59'	440 x 132 x 680 + 440 x 132 x 680 (x5)	3 101 78 + 3 106 64 (x5)

NOTE: the stated backup times in minutes are estimated and may vary according to the load characteristics, operating conditions and environment.

n Configuration

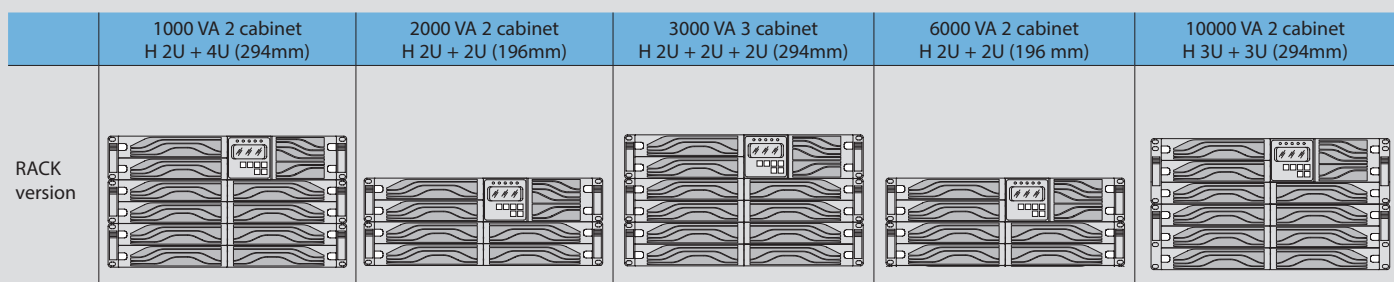
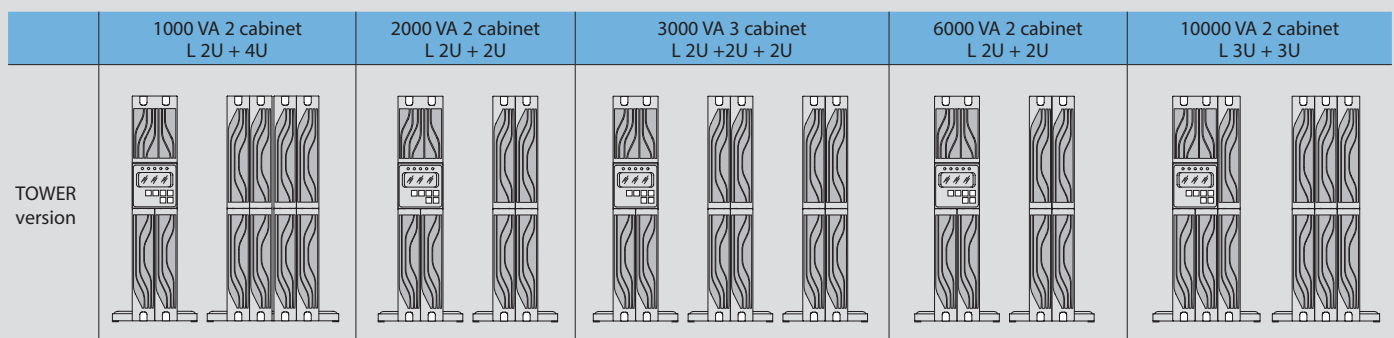

Keor S

Conventional UPS - Single-phase On-line double conversion



3 101 21

3 101 41

Characteristics:

- 3kVA to 10 KVA Capacity Range
- 1 Phase Input / 1 Phase Output
- IGBT Inverter - IGBT Rectifier
- High Efficiency
- Digital Signal Processor (DSP)
- High Input Power Factor (PFC)
- High Output Power Factor
- Low Input and Output Total Harmonic Distortion (THD)
- Generator Compatible Operation
- Standard IP31 Protection for Industrial Applications
- On Site Modular Paralleling Capability up to 4 Units (except 3kVA)
- Additional External Chargers for Long Back-Up Time Solutions (6-10kVA only)
- Availability of Different Communication Types
- User friendly diagnostic
- Advanced management and communication
- Integrated By-pass for maintenance
- LCD display with interactive menu

Item	Single-phase UPS			
	Nominal power (VA)	Active power (W)	Backup time (min)	Net weight (kg)
3 101 21	3000	2400	10	53
3 101 22	3000	2400	27	75
3 101 23	3000	2400	50	97
3 101 28	6000	5400	22	106
3 101 31	10000	9000	10	114

Item	Single-phase UPS with isolation transformer			
	Nominal power (VA)	Active power (W)	Backup time (min)	Net weight (kg)
3 101 25	3000	2400	10	85
3 101 29	6000	5400	0	100
3 101 35	10000	9000	0	126

Battery cabinet

Description

- 3 107 40 Empty battery cabinet
- 3 107 41 Battery cabinet (for KEOR S 3000)
- 3 107 42 Battery cabinet (for KEOR S 3000)
- 3 107 43 Battery cabinet (for KEOR S 3000)
- 3 107 44 Battery cabinet (for KEOR S 6000-10000)
- 3 107 45 Battery cabinet (for KEOR S 6000-10000)

Accessories

Description

- 3 109 61 Battery charger for additional battery cabinet (for 3 107 41 - 3 107 42 - 3 107 43)
- 3 109 54 Battery charger for additional battery cabinet (for 3 107 44 - 3 107 45)

NOTE: The stated Backup times in minutes are estimated and may vary according to the load characteristics, operating conditions and environment.

For the choice of communication accessories, see the dedicated section of this catalogue.

- n UPS with internal batteries Backup time up to 50 min for 3 kVA

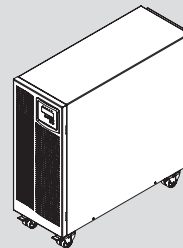

- n UPS for long Backup time with additional battery cabinet

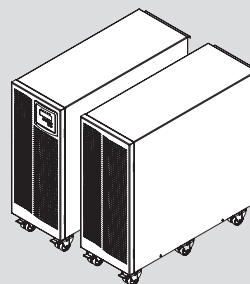

- n UPS with isolation transformer built in

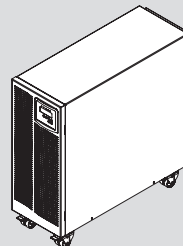

- n Rear pannel

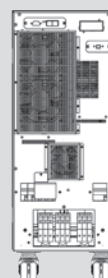

- n Long Backup time table

Power	UPS	Battery cabinet	Backup time (min.)
6000	3 101 28	3 107 44	55
6000	3 101 28	3 107 45	85
10000	3 101 31	3 107 44	27
10000	3 101 31	3 107 45	50
6000	3 101 29	3 107 45	55
6000	3 101 29	3 107 44	22
10000	3 101 35	3 107 44	10
10000	3 101 35	3 107 45	27

Keor S

Conventional UPS - Single-phase On-line double conversion

Characteristics

General characteristics	3 kVA	6 kVA	10 kVA
Nominal power (VA)	3000	6000	10000
Active power (W)	2400	5400	9000
Technology	On-line double conversion		
Waveform	Sinusoidal		
Architecture	conventional UPS		
Input characteristics			
Input voltage	220V-230V-240V		
Input frequency	45-65 Hz		
Input voltage range	160V-288V	195V-280 V	
THD of input current	6%		
Input power factor	> 0,99		
Output characteristics			
Output voltage	220V/230V/240V Adjustable from Front Panel		
Output frequency (nominal)	50 /60 Hz Adjustable from Front Panel +/- 0,05%		
Crest factor	2,5:1		
THD of output voltage	< 1,5% with linear load < 3% with non-linear load		
Overload capacity	10 seconds at 125%-150% 30 seconds at 106%-120%	120 seconds at 100%-120% 30 seconds at 121%-150%	
Efficiency in Eco mode	98%		
Bypass	-	Automatic bypass and manual maintenance bypass	
Batteries			
Backup time extension	Yes		
Communication and management			
LCD Display	Available		
Communication Port	1 RS232 serial ports, 1 USB port, modbus and SNMP optional	1 RS232 serial ports, modbus and SNMP optional	
Remote Management	Available		
Mechanical characteristics			
Dimensions H x W x D (mm)	716 x 275 x 776		
Dimensions battery cabinet H x W x D (mm)	716 x 275 x 776		
Ambient conditions			
Operating temperature (°C)	0 - 40		
Relative humidity (%)	<95% (non condensing)		
Protection index	IP31		
Noise at 1 m (dBA)	< 50		
Compliance			
Reference product standards	EN 62040-1, EN 62040-2, EN 62040-3		

MODULAR UPS

Its continuous research combined with modern production methods has allowed **Legrand to launch state-of-the-art modular UPS units on the market**, with top ranking performances: efficiency certified up to 96,5% and unit power factor.

Thanks to the high-performance components and space-efficient structures, these products are the ideal solution for advanced energy management and cost containment.

The Legrand modular UPS units are high frequency PWM uninterruptible power supplies, On Line type with Double Conversion, modular architecture, and redundant N+X configuration option.

They can be sized to meet the customer's needs, without precluding any future implementations.

The products that are part of this version are:

**Megaline - Trimod HE -
Trimod MCS - Keor MOD**

HIGH performances
HIGH efficiency
RESPECT of the environment



Megaline
Megaline Rack
from 1.25 to 10 kVA

Trimod HE
Trimod HE
from 10 to 80 kVA

Keor MOD
Keor MOD
from 25 to 250 kVA

CERTIFIED EFFICIENCY

The Legrand modular UPS guarantee exceptionally high efficiency values, up to 4% higher than the minimum values required by the European Code of Conduct (92%).

96,5%

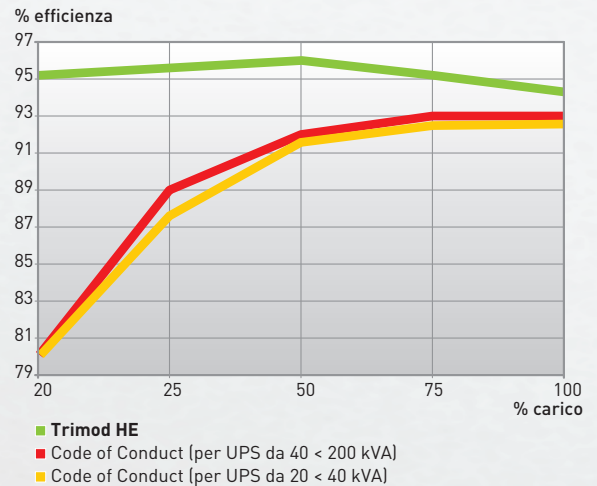

Increase in stand-by time and power

The different models are composed by STANDARD modules that can be added to existing UPS units to extend both power and backup time and guarantee maximum levels of redundancy.

Scalability of backup times

The expansion can be performed quickly and easily by adding battery drawers to the same cabinet, depending on the power of the UPS and the backup time requirements.



Single drawer with 5 9Ah batteries for Trimod HE and Trimod MCS.



Battery drawer for Keor MOD, designed to contain up to 24 9 or 11 Ah batteries.

Power and redundancy modules

The power modules are available in both single-phase and three-phase versions, depending on the power of the UPS. Both models guarantee low weight and overall dimensions along with top ranking performance. Thanks to the construction technology the various redundancy levels can be set to always guarantee maximum service continuity.



Single phase power module for Trimod HE and Trimod MCS. Compact and lightweight (only 8.5 kg)



Three-phase power module for Keor MOD. Reaches a power output of 25 kW with just 2 rack units required

MODULAR UPS

High redundancy levels

Redundancy on single phase load

In a three-phase power supply system with single phase loads, if one of the modules fails, there is no loss of power as the power is distributed over the other modules that are still operational.

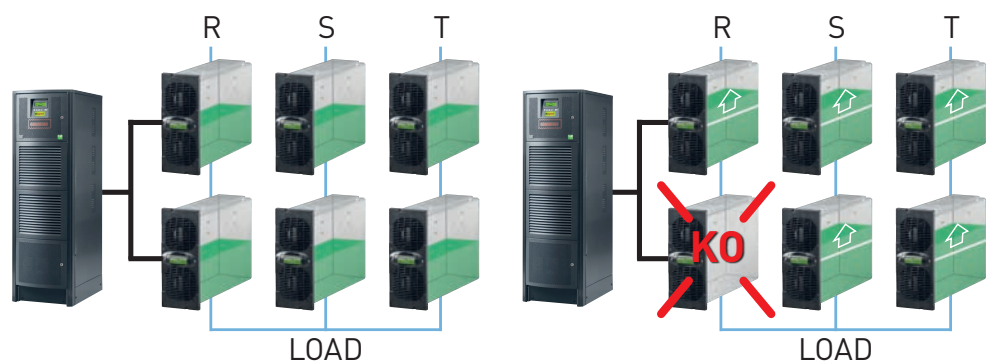

Phase redundancy

In a system with three-phase outputs, it is possible to create redundancy on each individual phase. If one of the power modules fails, the other modules for this phase take over from the faulty module.

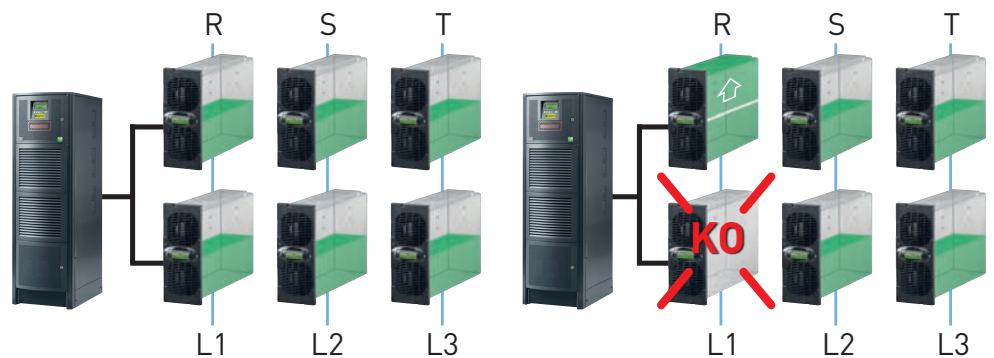

Control module redundancy

In UPS that include several control modules, the failure of one of the control modules results in the modules it controls being stopped. However continuity of service is assured by the automatic distribution of the lost power over the other modules.

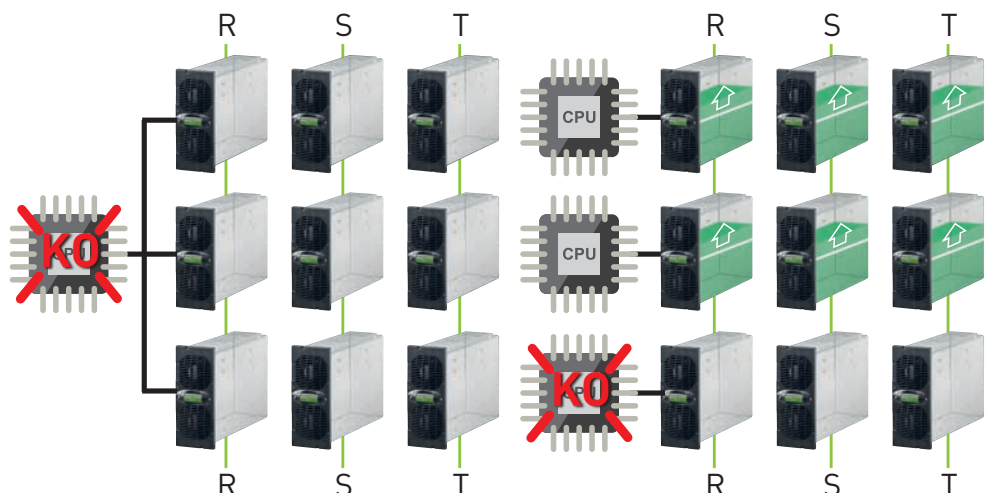

EXCLUSIVE ROTATING TOUCH SCREEN DISPLAY

The Keor MOD has a 10" touch screen display provides a simplified control panel packed with information, alerts and settings and is also equipped with interactive icons to make navigation and selection of the functions to be controlled quick and simple. The possibility of being able to rotate the Display inwards by 180° simplifies and speeds up the configuration and maintenance phases.

The display is positioned vertically so you have both the operating block diagram and the UPS layout with all the available information all on the same screen.



Decentralised bypass system

The decentralised bypass architecture reduces repair and maintenance time and costs. Each power module contains an independent bypass that, in the event of a failure, allows the remaining modules to simply to bypass mode, ensuring full functionality. The complete independence of the modules makes it possible to perform all maintenance and expansion phases in an extremely swift and simple way.



Attention to design

The elegance of the design and the skilful choice of materials give the Legrand UPS units a sleek and cutting-edge look.



MODULAR UPS



Megaline and Megaline Rack

These are the only single-phase UPS units in the modular range. The single cabinet and 19" rack deliver a power of 1250 to 5000 VA and can house a maximum of 4 power modules and 4 battery kits. The range also includes double cabinets with a nominal power of up to 10000 VA. Further batteries can be housed in specific cabinets, and are easy to connect thanks to the backup extension fittings.

There are 3 versions available:

- SINGLE CABINET
- DOUBLE CABINET
- 19" RACK CABINET

Keor MOD

It is an uninterruptible power supply based on three phase power modules, extremely compact and easy to handle. It delivers a nominal power from 25 to 250 kVA, it can be connected in parallel with other units up to 600 kVA.

Models up to 125 kVA have internal batteries for 5 minute backup time at 100% load.

Keor MOD integrates perfectly with the most critical applications such as Data Centers.

Trimod HE

It consists of individual redundant and self-configuring single phase modules and has a nominal power rating of 10 to 80 kVA. Thanks to the construction technology the various redundancy levels can be set to always guarantee maximum service continuity.



Trimod MCS

The Trimod MCS CPS (Central Power Supply) is a single phase and three-phase centralised power supply system designed according to EN 50171 standards and represents the ideal solution for installation in buildings subject to fire safety standards and, specifically, to power emergency lighting systems. It can also be used to power emergency systems such as automatic fire extinguishing systems, emergency detection and alarm systems, smoke exhaust and carbon dioxide detection devices and specific safety systems in sensitive areas.

Megaline

Modular single-phase double conversion UPS VFI



3 103 60 + 3 107 78



3 108 77



3 107 85



3 108 35

Characteristics:

- Modular single-phase UPS
- Power from 1250 to 10000 VA
- On-Line double conversion VFI-111
- Adaptable, expandable and redundant solutions in a single cabinet
- Swift and simple maintenance and management
- Low environmental impact (high efficiency and reduced footprint)
- Single or double cabinet UPS unit depending on the output power
- Wide range of input voltage and frequency ranges
- Operating frequency of 50 - 60 Hz with self-recognition mode
- Frequency converter 50 in - 60 out or vice versa
- Extension of the input frequency rate for operations with genset units
- Eco Mode operations (energy saving)
- Load waiting mode operations (protection on demand)
- Output voltage adjustable in 1 volt steps from the front control panel
- Very low noise level
- Internal and external temperature reader
- Controls ventilation depending on the temperature and load
- Emergency remote shutdown option

Item	Single cabinet (German standard)				
	Nominal power (VA)	Active power (W)	Back-up time (min.)	No. Cabinet	Weight (kg)
3 103 50	1250	875	13	1	23.5
3 103 52	2500	1750	13	1	34
3 103 54	3750	2625	13	1	43
3 103 56	5000	3500	13	1	53

Double Cabinet					
	Nominal power (VA)	Active power (W)	Back-up time (min.)	No. Cabinet	Weight (kg)
3 103 60 + 3 107 78	5000	3500	13	2	24+50
3 103 63 + 3 107 79	6250	4375	13	2	27+58
3 103 66 + 3 107 80	7500	5250	13	2	29+65
3 103 69 + 3 107 81	8750	6125	13	2	32+73
3 103 72 + 3 107 82	10000	7000	13	2	34+80

Single cabinet (French standard)					
	Nominal power (VA)	Active power (W)	Back-up time (min.)	Number of cabinets	Weight (kg)
3 103 42	1250	875	13	1	23.5
3 103 43	2500	1750	13	1	34
3 103 44	3750	2625	13	1	43
3 103 45	5000	3500	13	1	53

NOTE: the stated backup times in minutes are estimated and may vary according to the load characteristics, operating conditions and environment.

Item	Single cabinet - without batteries			
	Nominal power (VA)	Active power (W)	Back-up time (min.)	Number of cabinets
3 103 51	1250	875	13	1
3 103 53	2500	1750	13	1
3 103 55	3750	2625	13	1
3 103 57	5000	3500	13	1

Double cabinet - without batteries				
	Nominal power (VA)	Active power (W)	Back-up time (min.)	Number of cabinets
3 103 60 + 3 108 59	5000	3500	-	2
3 103 63 + 3 108 59	6250	4375	-	2
3 103 66 + 3 108 59	7500	5250	-	2
3 103 69 + 3 108 59	8750	6125	-	2
3 103 72 + 3 108 59	10000	7000	-	2

with charger			Battery extensions	
3 107 75	3 107 86	Cabinet with 1 bk		
3 107 76	3 107 87	Cabinet with 2 bk		
3 107 77	3 107 88	Cabinet with 3 bk		
3 107 78	3 107 89	Cabinet with 4 bk		
3 107 79	3 107 90	Cabinet with 5 bk		
3 107 80	3 107 91	Cabinet with 6 bk		
3 107 81	3 107 92	Cabinet with 7 bk		
3 107 82	3 107 93	Cabinet with 8 bk		
3 107 83	3 107 94	Cabinet with 9 bk		
3 107 84	3 107 95	Cabinet with 10 bk		

Accessories	
3 108 35	Power module (PW 1250)
3 108 57	Single cabinet backup extension (bk Megaline/1)
3 108 58	Double cabinet backup extension (bk Megaline/2)
3 108 59	Empty battery cabinet
3 108 60	Y cable for connecting a second additional battery cabinets (check the long life tables for the number of cables)
3 108 61	Battery cabinet extension kit for tower configuration (Megaline PL cable)
3 108 77	Manual bypass for single cabinet (BP/1)
3 108 78	Manual bypass for double cabinet (BP/2)
3 107 85	Additional battery charger (CB 36)
3 109 72	Relay interface kit

For the choice of communication accessories, see the dedicated section of this catalogue.

bk: battery kit

Megaline Rack

Modular single-phase double conversion UPS VFI



3 103 85



3 107 96



3 108 77



3 107 85



3 109 73

Characteristics:

- Modular single-phase UPS
- Output from 1250 to 5000 VA
- Wide range of input voltage and frequency ranges
- Operating frequency of 50 - 60 Hz with self-recognition mode
- Frequency converter 50 in - 60 out or vice versa
- Extension of the input frequency rate for operations with genset units
- Eco Mode operations (energy saving)
- Load waiting mode operations (protection on demand)
- Output voltage adjustable in 1 volt steps from the front control panel
- Very low noise level
- Internal and external temperature reader
- Controls ventilation depending on the temperature and load
- Emergency remote shutdown option

Item	Racks (German standard)				
	Nominal power (VA)	Active power (W)	Backup time (min)	Number of cabinets	Weight (kg)
3 103 79	1250	875	13	1	23.5
3 103 81	2500	1750	13	1	34
3 103 83	3750	2625	13	1	43
3 103 85	5000	3500	13	1	53

Item	Racks (French standard)				
	Nominal power (VA)	Active power (W)	Backup time (min)	Number of cabinets	Weight (kg)
3 103 34	1250	875	13	1	23.5
3 103 35	2500	1750	13	1	34
3 103 36	3750	2625	13	1	43
3 103 37	5000	3500	13	1	53

Item	Racks (British standard)				
	Nominal power (VA)	Active power (W)	Backup time (min)	Number of cabinets	Weight (kg)
3 103 38	1250	875	13	1	23.5
3 103 39	2500	1750	13	1	34
3 103 40	3750	2625	13	1	43
3 103 41	5000	3500	13	1	53

Item	Racks - without batteries				
	Nominal power (VA)	Active power (W)	Backup time (min)	Number of cabinets	Weight (kg)
3 103 80	1250	875	-	1	23.5
3 103 82	2500	1750	-	1	34
3 103 84	3750	2625	-	1	43
3 103 86	5000	3500	-	1	53

Item	Backup time extensions		
	Nominal power (VA)	Additional BK	Expansion (min)
3 103 87	1250	1	30
3 103 88	1250	2	52
3 103 89	1250	3	75
3 103 90	2500	1	22
3 103 91	2500	2	30
3 103 92	3750	1	18

Battery expansions for Rack UPS

3 107 96	Rack with 1 bk
3 107 97	Rack with 2 bk
3 107 98	Rack with 3 bk
3 107 99	Rack with 4 bk
3 108 00	Rack with 1 bk with charger
3 108 01	Rack with 2 bk with charger
3 108 02	Rack with 3 bk with charger
3 108 03	Rack with 4 bk with charger

Accessories

3 108 35	Power module (PW 1250)
3 108 77	Manual bypass for single cabinet (BP/1)
3 107 85	Additional charger (CB 36)
3 109 72	Relay interface kit
3 109 73	Telescopic runner kit for 6U rack

bk: battery kit

NOTE: The stated backup times in minutes are estimated and may vary according to the load characteristics, operating conditions and environment.

For the choice of communication accessories, see the dedicated section of this catalogue.

Megaline and Megaline Rack

Modular single-phase double conversion UPS VFI

Characteristics

General Characteristics	3 103 42	3 103 43	3 103 44	3 103 45	3 103 60 + 3 107 78	3 103 63 + 3 107 79	3 103 66 + 3 107 80	3 103 69 + 3 107 81	3 103 72 + 3 107 82
	3 103 46	3 103 47	3 103 48	3 103 49					
	3 103 50	3 103 52	3 103 54	3 103 56					
	3 103 34	3 103 35	3 103 36	3 103 37					
	3 103 38	3 103 39	3 103 40	3 103 41					
	3 103 79	3 103 81	3 103 83	3 103 85					
	Single CABINET and RACK				Double CABINET				
Nominal power (VA)	1250	2500	3750	5000	5000	6250	7500	8750	10000
Active power (W)	875	1750	2625	3500	3500	4375	5250	6125	7000
Max. expansion (VA)	5000				10000				
Max. expansion (W)	3500				7000				
Technology	On-Line double conversion (VFI-SS-111)								
UPS Architecture	Modular, expandable, redundant N+X with 1250 VA Power modules, contained in one single Cabinet/ Rack								
Input									
Nominal input voltage	230 V								
Input voltage range	184 - 264 VAC at 100% load								
Minimum operating voltage	100 VAC at 50% load								
THD Input current	< 3%								
Input Power Factor	> 0.99 from 20% load								
Input frequency	50 Hz / 60 Hz ± 2% autosensing								
Output									
Output voltage	230 V ± 1%								
Frequency output	50 Hz / 60 Hz synchronised								
THD Output Voltage	< 1% with non-linear load								
Waveform	Sinusoidal								
Peak Factor	3:1								
Efficiency	up to 92%								
Overload capacity	300% for 1 sec, 200% for 5 sec, 150% for 30 sec								
Batteries									
Backup time extension	Yes								
Accessories supplied									
Bypass	Automatic, internally synchronised, static and electromechanical (for overloads and operating problems)								
Alarms and signals	Wide screen with 4 alphanumeric lines, multi-coloured status indicator, audible signalling								
Communication ports	1 RS232 port 2 logic level ports								
Protections	Electronic devices for protection against overloads, short-circuits and excessive battery discharge. Operation stops at end of Backup time. Inrush current limiter on start-up. Sensor for correct neutral switching. Back-feed protection (electrical safety insulation of the input plug during battery-based operation). EPO (emergency power off) contact.								
IN/ OUT mains connection	German standard/terminal connector with universal multi-socket outlet (Italian/German standard)								
Mechanical characteristics									
Net weight (kg)	23.5	34	43	53	24 + 50	26.5+57.5	29 + 65	31.5+72.5	34 + 80
Megaline Dimensions (HxWxD) (mm)	475 x 270 x 570				2 x 475 x 270 x 570				
Megaline Rack Dimensions (HxWxD) (mm)	266 x 483 x 582				-				
Power modules installed	1	2	3	4	4	5	6	7	8
Free power expansion slots	3	2	1	-	4	3	2	1	-
Installed battery kits	1	2	3	4	4	5	6	7	8
Free backup extension slots	3	2	1	-	6	5	4	3	2
Ambient conditions									
Operating temperature (°C)	0 – 40								
Protection rating	IP20								
Relative humidity (%)	< 95% (non condensing)								
Noise at 1 m from the unit (dBA)	< 40								
Certifications									
Standards	EN 62040-1, EN 62040-2, EN 62040-3								
Warranty									
Standard Warranty	2 years with the On Site formula batteries included, interventions c/o the installation location								

Megaline and Megaline Rack

Modular single-phase double conversion UPS VFI

n Long backup time table for single and double cabinet versions

Model	Power	Back-up time	no. cabinets and dimensions HxWxD (mm)	Codes
Single Cabinet				
	1,250 VA	30'	1x (270 x 475 x 570)	3 103 73
	1,250 VA	52'	1x (270 x 475 x 570)	3 103 74
	1,250 VA	75'	1x (270 x 475 x 570)	3 103 75
	2,500 VA	22'	1x (270 x 475 x 570)	3 103 76
	2,500 VA	30'	2x (270 x 475 x 570)	3 103 77
	2,500 VA	52'	2x (270 x 475 x 570)	3 103 52 + 3 107 78
	2,500 VA	63'	2x (270 x 475 x 570)	3 103 52 + 3 107 79
	3,750 VA	18'	1x (270 x 475 x 570)	3 103 78
	3,750 VA	29'	2x (270 x 475 x 570)	3 103 54 + 3 107 77
	3,750 VA	44'	2x (270 x 475 x 570)	3 103 54 + 3 107 79
	3,750 VA	67'	2x (270 x 475 x 570)	3 103 54 + 3 107 82
	5,000 VA	22'	2x (270 x 475 x 570)	3 103 56 + 3 107 76
	5,000 VA	30'	2x (270 x 475 x 570)	3 103 56 + 3 107 78
	5,000 VA	46'	2x (270 x 475 x 570)	3 103 56 + 3 107 81
	5,000 VA	63'	2x (270 x 475 x 570)	3 103 56 + 3 107 84
Double Cabinet				
	5,000 VA	22'	2x (270 x 475 x 570)	3 103 60 + 3 107 80
	5,000 VA	30'	2x (270 x 475 x 570)	3 103 60 + 3 107 82
	5,000 VA	46'	3x (270 x 475 x 570)*	3 103 60 + 3 107 84 + 3 107 75
	5,000 VA	63'	3x (270 x 475 x 570)*	3 103 60 + 3 107 84 + 3 107 78
	6,250 VA	20'	2x (270 x 475 x 570)	3 103 63 + 3 107 81
	6,250 VA	30'	2x (270 x 475 x 570)	3 103 63 + 3 107 84
	6,250 VA	47'	3x (270 x 475 x 570)*	3 103 63 + 3 107 84 + 3 107 78
	6,250 VA	60'	3x (270 x 475 x 570)*	3 103 63 + 3 107 84 + 3 107 81
	7,500 VA	18'	2x (270 x 475 x 570)	3 103 66 + 3 107 82
	7,500 VA	30'	3x (270 x 475 x 570)*	3 103 66 + 3 107 84 + 3 107 76
	7,500 VA	48'	3x (270 x 475 x 570)*	3 103 66 + 3 107 84 + 3 107 81
	7,500 VA	59'	3x (270 x 475 x 570)*	3 103 66 + 3 107 84 (x2)
	8,750 VA	20'	2x (270 x 475 x 570)	3 103 69 + 3 107 84
	8,750 VA	30'	3x (270 x 475 x 570)*	3 103 69 + 3 107 84 + 3 107 78
	8,750 VA	45'	3x (270 x 475 x 570)*	3 103 69 + 3 107 84 + 3 107 83
	8,750 VA	61'	4x (270 x 475 x 570)*	3 103 69 + 3 107 84 (x2) + 3 107 78
	10,000 VA	22'	3x (270 x 475 x 570)*	3 103 72 + 3 107 84 + 3 107 76
	10,000 VA	30'	3x (270 x 475 x 570)*	3 103 72 + 3 107 84 + 3 107 80
	10,000 VA	46'	4x (270 x 475 x 570)*	3 103 72 + 3 107 84 (x2) + 3 107 76
	10,000 VA	60'	4x (270 x 475 x 570)*	3 103 72 + 3 107 84 (x2) + 3 107 81

* The configuration requires the use of a Y 3 108 60 connection cable (the number of cables required is equal to the no. of cabinets -2)

n Long backup time table for rack versions

Model	Power	Back-up time	no. cabinets and dimensions HxWxD (mm)	Codes
Rack				
	1,250 VA	30'	1 (6U)	3 103 87
	1,250 VA	52'	1 (6U)	3 103 88
	1,250 VA	75'	1 (6U)	3 103 89
	2,500 VA	22'	1 (6U)	3 103 90
	2,500 VA	30'	1 (6U)	3 103 91
	2,500 VA	52'	2 (6U + 3U)	3 103 81 + 3 107 99
	2,500 VA	63'	3 (6U + 2x3U)	3 103 81 + 3 107 99 + 3 107 96
	3,750 VA	18'	1 (6U)	3 103 92
	3,750 VA	29'	2 (6U + 3U)	3 103 83 + 3 107 98
	3,750 VA	44'	3 (6U + 2x3U)	3 103 83 + 3 107 99 + 3 107 96
	3,750 VA	67'	3 (6U + 3x3U)	3 103 83 + 3 107 99 (x2)
	5,000 VA	22'	2 (6U + 3U)	3 103 85 + 3 107 97
	5,000 VA	30'	2 (6U + 2x3U)	3 103 85 + 3 107 99
	5,000 VA	46'	3 (6U + 3x3U)	3 103 85 + 3 107 99 + 3 107 98
	5,000 VA	63'	4 (6U + 4x3U)	3 103 85 + 3 107 97 + 3 107 99 (x2)
			6U= 483 x 266 x 582 3U= 483 x 133x 584	

NOTE: the stated backup times in minutes are estimated and may vary according to the load characteristics, operating conditions and environment.

Trimod HE

Modular three-phase double conversion UPS VFI



3 104 42



3 108 71



3 108 45

Characteristics:

- Modular three-phase UPS
- Power from 1 to 80 kVA
- On-Line double conversion VFI-SS-111
- High efficiency up to 96%
- Output factor 1
- Adaptable, redundant and scalable solutions (IN/OUT 3-1 phase configuration)
- Quick and simple maintenance
- Low environmental impact
- Diagnostics, monitoring, historical data and parameters that can be set on the screen
- Reduced foot print and dimensions
- Taller cabinet to extend backup time and standard configurations
- Multi control board function
- Dual Input Function
- Hot Swap system
- Menu available in 7 languages
- Frequency converter in 40-70Hz out 50/60Hz (selectable)
- Operations with genset
- Three independent phase outputs
- Bypass line input
- Eco Mode
- EPS Mode
- Output voltage adjustable in 1 volt steps (190÷245V)
- Bypass speed regulation
- Event log complete with date and time
- Global and historic data of each power module

Item	UPS	Power (kVA)	Back-up time (min.)	No. and Type Cabinet	Weight (kg)
3 104 42	10	11	1A	167	
3 104 43	10	21	1A	223	
3 104 44	10	35	1A	279	
3 104 02	10	49	1B	350	
3 104 45	15	13	1A	220	
3 104 46	15	21	1A	279	
3 104 07	15	29	1B	350	
3 104 47	20	9	1A	220	
3 104 48	20	14	1A	279	
3 104 13	20	20	1B	350	
3 104 17	30	8	1B	325	
3 104 19 + 3 107 63	40	8	2A	564	
3 104 20 + 2 x 3 107 63	60	10	3A	830	
3 110 08 + 3 104 78	80	9	2B	992	

Cabinet A h=1370, Cabinet B h=1650

Item	Accessories
3 108 69	Output module 3.4 kVA
3 108 71	Output module 5 kVA
3 108 73	Output module 6.7 kVA
3 108 51	Additional battery charger module 15 A

Item	Battery accessories
3 108 54	Kit of 4 empty battery drawers
3 108 45	Single drawer with 5 9Ah long life batteries (installed in multiples of 4)
3 108 75	Single drawer with 5 9Ah long life batteries (installed in multiples of 4)
3 109 29	Kit for separate batteries (only for 60-80 kVA)

Item	Additional empty battery cabinet
3 108 05	16-drawer modular battery cabinet
3 108 06	20-drawer modular battery cabinet

Item	Additional battery cabinet with 9Ah batteries
3 107 60	4-drawer modular battery cabinet
3 107 61	8-drawer modular battery cabinet
3 107 62	12-drawer modular battery cabinet
3 107 63	16-drawer modular battery cabinet
3 107 64	20-drawer modular battery cabinet

Item	Power cabinet	Power (kVA)	No. of installable battery drawers	No. of phases	Type Cabinet	Weight (kg)
3 103 96	10	12	1-1 / 3-3 / 3-1 / 1-3	A	120	
3 103 97	10	16	1-1 / 3-3 / 3-1 / 1-3	B	155	
3 104 08	15	12	1-1 / 3-3 / 3-1 / 1-3	A	120	
3 104 03	15	16	1-1 / 3-3 / 3-1 / 1-3	B	155	
3 104 14	20	12	1-1 / 3-3 / 3-1 / 1-3	A	120	
3 104 09	20	16	3-3	B	155	
3 104 18	30	-	3-3	A	146	
3 104 15	30	12	3-3	B	181	
3 104 19	40	-	3-3	A	146	
3 104 20	60	-	3-3	A	165	
3 110 08	80	-	3-3	B	220	

Item	Power cabinets (empty)	No. of installable power modules	No. of installable battery drawers	No. of phases	Type Cabinet	Weight (kg)
3 104 22	3 x 3.4 kVA	12	1-1 / 3-3 / 3-1 / 1-3	A	85	
3 104 31	3 x 3.4 kVA	16	1-1 / 3-3 / 3-1 / 1-3	B	98	
3 104 23	3 x 5 o 6,7 kVA	12	1-1 / 3-3 / 3-1 / 1-3	A	90	
3 104 32	6 x 3.4 kVA	12	1-1 / 3-3 / 3-1 / 1-3	B	102	
3 104 33	3 x 5 o 6,7 kVA	16	1-1 / 3-3 / 3-1 / 1-3	B	102	
3 104 24	6 x 5 kVA	-	3-3	A	80	
3 104 25	6 x 5 kVA	-	1-1/3-3/3-1/1-3	A	84	
3 104 34	6 x 5 kVA	12	3-3	B	104	
3 104 26	6 x 6.7 kVA	-	3-3	A	80	
3 104 27	9 x 6.7 kVA	-	3-3	A	90	

Item	Power cabinets with MULTI CONTROL BOARD (empty)	No. of installable power modules	No. of installable battery drawers	No. of phases	Type Cabinet	Weight (kg)	No. of controls
3 104 68	6x3.4 or 5 kVA	-	1-1/3-3/3-1/1-3	A	85	2	
3 104 69	6 x 5 kVA	12	3-3	B	106	2	
3 104 71	6 x 6.7 kVA	-	3-3	A	82	2	
3 104 72	9 x 6.7 kVA	-	3-3	A	91	3	
3 104 73	12 x 6.7 kVA	-	3-3	B	120	4	

Item	Additional battery cabinet with long life batteries
3 104 70	Battery cabinet for Trimod type A
3 104 78	Battery cabinet for Trimod type B

NOTE: the stated backup times in minutes are estimated and may vary according to the load characteristics, operating conditions and environment.



For the choice of communication accessories, see the dedicated section of this catalogue.

Trimod HE

Modular three-phase double conversion UPS VFI

Characteristics

General Characteristics	3 103 96	3 104 03	3 104 09	3 104 15*	3 104 19	3 104 20	3 104 73
	3 103 97	3 104 08	3 104 14	3 104 18* 3 104 68 3 104 69	3 104 71	3 104 72	3 110 08
Nominal power (kVA)	10	15	20	30	40	60	80
Active power (kW)	10	15	20	30	40	60	80
Module power (kVA)	3.4	5	6.7	5	6.7	6.7	6.7
Technology	On-Line Double Conversion VFI-SS-111						
System	Modular, expandable and redundant UPS system						
Input specifications							
Input voltage	380, 400, 415 3F+N+PE (or 220, 230, 240 1F)			380, 400, 415 3F+N+PE			
Input frequency	45-65 Hz (43,0 ÷ 68,4 Hz)						
Input voltage range	400V +15%/-20% - 230V +15%/-20%			400V +15%/-20%			
THD Input current	< 3% (at full load)						
Compatibility with genset	Yes						
Input Power Factor	> 0.99						
Output Specifications							
Output voltage	380, 400, 415 3F+N+PE (or 220, 230, 240 1F)			380, 400, 415 3F+N+PE			
Efficiency	Up to 96%						
Efficiency in Eco Mode	99%						
Nominal output frequency	50/60 Hz selectable by the user ±2 % (standard), ±14 % (extended)						
Peak factor	3:1						
Waveform	Sinusoidal						
Output Voltage Tolerance	±1%						
THD Output Voltage	< 1%						
Overload capacity	10 minutes at 115%, 60 seconds at 135%						
Bypass	Automatic bypass (static and electromechanical) and manual maintenance bypass						
Batteries							
Battery module	Plug & Play						
Battery series type/voltage	VRLA - AGM /240 Vd.c.						
Back-up time	Configurable						
Battery charger	Smart Charge Technology. 3-stage advanced cycle						
Independent battery configuration	No		Yes			Yes with KIT	
Communication and management							
Screen and signalling	4 20-character rows, 4 menu navigation buttons, multi-colour LED status indicator, alarms and acoustic signals						
Communication ports	2 RS232 ports, 1 logic level port, 5 floating contact ports, 1 interface slot						
Back feed protection	NC/NO auxiliary contact						
Emergency Power Off (EPO)	Yes						
Remote control	Available						
Mechanical characteristics							
Height A-B (mm)	1370 - 1650						
Width (mm)	414	414	414	414	414	414	414
Depth (mm)	628	628	628	628	628	628	628
Number of Installed Power Modules	3	6	6	9	12		
Installable battery drawers (A-B)	Up to 12 - Up to 16		Up to 0 - 12	-	-	-	-
Net weight A-B (kg)	Refer to the previous page, where there are the weights of the various configurations						
Ambient Conditions							
Operating temperature/humidity	0 - 40°C / 0 - 95% non condensing						
Protection rating	IP21						
Noise at 1 m from the unit (dBA)	58-62						
Estimated content of circular economy derived materials	37%						
Recyclability rate calculated using the method described in technical report IEC/TR 62635**	84%						
Certifications							
Standards	EN 62040-1, EN 62040-2, EN 62040-3						
Services							
Installation	User executable, modular architecture with "Plug & Play" power modules and batteries						
Maintenance	User executable, availability of optional services provided by the manufacturer						
Ease of management	Advanced diagnostic functions via the touch screen display						

* Standard configurations with 3-3 distribution (multi IN/OUT settings available upon request)

** This value is based on data collected from a technological channel operating on an industrial basis. It does not pre-validate the effective use of this channel for end-of-life of this product.

Trimod HE

Long backup times table



Modular battery cabinet
with up to 20
battery drawers installable
Total - 100 Batteries



Non modular
battery cabinet
up to 20 battery
drawers installable*

Trimod HE	Battery cabinet type	Nominal power (kVA)	Back-up time	Dimensions HxWxD (mm)	Weight (kg)
3 104 44 + 3 107 61	modular	10	78	2 x 1370 x 414 x 628	472
3 104 46 + 3 107 60	modular	15	33	2 x 1370 x 414 x 628	413
3 104 08 + 3 104 78	non modular	15	110 *	1370 x 414 x 628 + 1635 x 600 x 800	902
3 104 46 + 3 107 63	modular	15	57	2 x 1370 x 414 x 628	550
3 104 48 + 3 107 62	modular	20	35	2 x 1370 x 414 x 628	572
3 104 14 + 3 104 78	non modular	20	82 *	1370 x 414 x 628 + 1635 x 600 x 800	865
3 104 18 + 3 107 63	modular	30	12	2 x 1370 x 414 x 628	434
3 104 18 + 3 104 78	non modular	30	50 *	1370 x 414 x 628 + 1635 x 600 x 800	890
3 104 18 + 2 x 3 104 78	non modular	30	110 *	1370 x 414 x 628 + 2 x 1635 x 600 x 800	1645
3 104 19 + 2 x 3 107 63	modular	40	20	3 x 1370 x 414 x 628	801
3 104 19 + 3 108 10	non modular	40	33 *	1370 x 414 x 628 + 1635 x 600 x 800	925
3 104 19 + 2 x 3 104 78	non modular	40	82 *	1370 x 414 x 628 + 2 x 1635 x 600 x 800	1700
3 104 19 + 3 x 3 104 78	non modular	40	120 *	1370 x 414 x 628 + 3 x 1635 x 600 x 800	2430
3 104 19 + 3 x 3 107 64	modular	40	40	1370 x 414 x 628 + 3 x 1650 x 414 x 628	439
3 104 19 + 4 x 3 107 64	modular	40	60	1370 x 414 x 628 + 4 x 1650 x 414 x 628	1663
3 104 20 + 2 x 3 107 64	modular	60	15	1370 x 414 x 628 + 2 x 1650 x 414 x 628	942
3 104 20 + 4 x 3 107 63	modular	60	27	5 x 1370 x 414 x 628	1579
3 104 20 + 3 104 78	non modular	60	17 *	1370 x 414 x 628 + 1635 x 600 x 800	952
3 104 20 + 2 x 3 104 78	non modular	60	50 *	1370 x 414 x 628 + 2 x 1635 x 600 x 800	1715
3 104 20 + 3 x 3 104 78	non modular	60	80 *	1370 x 414 x 628 + 3 x 1635 x 600 x 800	2474
3 104 20 + 4 x 3 104 78	non modular	60	110 *	1370 x 414 x 628 + 4 x 1635 x 600 x 800	3234
3 110 08 + 2 x 3 104 70	non modular	80	20	1650X414X628+2X1635X600X800	1622
3 110 08 + 2 x 3 104 78	non modular	80	30	1650X414X628+2X1635X600X800	1782
3 110 08 + 3 x 3 104 78	non modular	80	47	1650X414X628+3X1635X600X800	2572
3 110 08 + 4 x 3 104 78	non modular	80	67	1650X414X628+4X1635X600X800	1782

* Configurations with long life battery cabinets.
310470 LONG LIFE BATTERY CABINET MODEL A - 710 kg - 600x800x1635 mm
310478 LONG LIFE BATTERY CABINET MODEL b - 790 kg - 600x800x1635 mm

NOTE: the stated backup times in minutes are estimated and may vary according to the load characteristics, operating conditions and environment.

Trimod MCS

CPS Modular three-phase double conversion VFI

**EN STANDARD
50171**



3 109 90



3 110 02



3 108 71



3 108 75

Characteristics:

- Modular single-phase and three-phase CPS
- Power from 3 to 80 kVA
- Conforms to EN-50171 Standards
- On-Line double conversion VFI-SS-111
- High efficiency up to 96%
- Output factor 1
- Adaptable, redundant and scalable solutions (IN/OUT 3-1 phase configuration)
- Quick and simple maintenance
- Low environmental impact
- Diagnostics, monitoring, historical data and parameters that can be set on the screen
- Reduced foot print and dimensions
- Taller cabinet to extend backup time and standard configurations
- Pre-configured solutions with 1h backup time
- Dual input function (Bypass line input)
- Hot Swap system
- Continuous operations at up to 120% of the load
- Protection against battery pole inversion
- Output configurable from the display as PERMANENT or NON PERMANENT
- Menu available in 7 languages
- Frequency converter in 40-70Hz out 50/60Hz (selectable)
- Operations with genset
- Three independent phase outputs
- Eco Mode
- Bypass speed regulation
- Event log complete with date and time
- Global and historic data of each power module

Item	Trimod MCS			
	Model	Autonomy according to EN50171	No. and Type Cabinet	IN-OUT factory settings
3 109 90	3	1h	1A	1-1
3 109 91	5	1h	1A	1-1
3 109 92	7	1h	1B	1-1
3 109 93 + 3 106 18	10	1h	1B	3-3
3 109 94 + 3 106 19	15	1h	1B	3-3
3 109 95 + 3 104 78	20	1h	1A	3-3
3 109 96 + 2 x 3 104 70	30	1h	1A	3-3
3 109 97 + 2 x 3 104 78	40	1h	1A	3-3
3 109 98 + 3 x 3 104 78	60	1h	1A	3-3
3 109 99 + 4 x 3 104 78	80	1h	1B	3-3

Cabinet A h=1370, Cabinet B h=1650

Item	Accessories
3 108 69	Output module 3.4 kVA
3 108 71	Output module 5 kVA
3 108 73	Output module 6.7 kVA
3 108 75	Battery accessories
	Single drawer with 5 9Ah long life batteries (installed in multiples of 4)

Item	Additional empty battery cabinet
3 110 07	16-drawer modular battery cabinet
3 106 16	20-drawer modular battery cabinet

Item	Additional battery cabinet with batteries Long Life
3 106 18	Modular battery cabinet with 3KB for CPS 10 KVA
3 106 19	Modular battery cabinet with 5 KB for CPS 15 KVA
3 104 70	Battery cabinet for CPS type A
3 104 78	Battery cabinet for CPS type B

Trimod MCS (Empty CPS Cabinets)					
Item	N° of installable power modules	N° of installable battery drawers	No. of phases	Type Cabinet	Weight (kg)
3 110 00	up to 3 to 3.4 kVA	12	1-1/3-3/3-1/1-3	A	86
3 110 01	up to 3 to 6.7 kVA	12	1-1/3-3/3-1/1-3	A	89
3 110 02	up to 3 to 6.7 kVA	16	1-1/3-3/3-1/1-3	B	103
3 110 03	up to 6 to 5 kVA	-	1-1/3-3/3-1/1-3	A	85
3 110 04	up to 6 to 6.7 kVA	-	3-3	A	82
3 110 05	up to 9 to 6.7 kVA	-	3-3	A	91
3 110 06	up to 12 to 6.7 kVA	-	3-3	B	120

NOTE: the stated backup times are estimated and may vary according to the load characteristics, operating conditions and environment.

For the choice of communication accessories, see the dedicated section of this catalogue.

Trimod MCS

CPS Modular three-phase double conversion VFI

Characteristics

General Characteristics	3 109 90	3 109 91	3 109 92	3 109 93+ 3 106 18	3 109 94+ 3 106 19	3 109 95+ 3 104 78	3 109 96+ 2x 3 104 70	3 109 97+ 2x 3 104 78	3 109 98+ 3x 3 104 78	3 109 99+ 4x 3 104 78
Nominal power (kVA)	3	5	6.7	10	15	20	30	40	60	80
Active power (kW)	3	5	6.7	10	15	20	30	40	60	80
Active power according to EN50171 (kW)	2.88	4.16	5.58	8	12.5	16.7	25	33.3	50	66.7
Technology	On-Line Double Conversion VFI-SS-111									
System	Modular, expandable and redundant UPS system									
Input specifications										
Input voltage	220,230,240 1F+N+PE			380, 400, 415 3F+N+PE * (o 220, 230, 240 1F)			380, 400, 415 3F+N+PE			
Input frequency	45-65 Hz (43,0 ÷ 68,4 Hz)									
Input voltage range	230V +15%/-20%			400V +15%/-20% - 230V +15%/-20%			400V +15%/-20%			
THD Input current	< 3% (at full load)									
Compatibility with power supply units	Yes									
Input power factor	> 0.99									
Output Specifications										
Output voltage	220,230,240 1F+N+PE			380, 400, 415 3F+N+PE * (o 220, 230, 240 1F)			380, 400, 415 3F+N+PE			
Efficiency	Up to 96%									
Efficiency in Eco Mode	99%									
Nominal output frequency	50/60 Hz selectable by the user ±2 % (standard), ±14 % (extended)									
Peak factor	3:1									
Waveform	Sinusoidal									
Output voltage tolerance	±1%									
THD output voltage	< 1%									
Overload capacity	120% continuous, 10 minutes at 135%, 60 seconds at 150%									
Bypass	Automatic bypass (static and electromechanical) and manual maintenance bypass									
Batteries										
Battery module	Plug & Play									
Type	Long Life									
Back-up time	1h (settable as needed)									
Battery charger	80% autonomy in 12h - Smart Charge technology. 3-stage advanced cycle									
Communication and management										
Screen and signalling	4 20-character rows, 4 menu navigation buttons, multi-colour LED status indicator, alarms and acoustic signals									
Communication Ports	2 RS232 serial ports, 1 logic level port, 5 floating contact ports, 1 interface slot									
Back feed protection	NC/NO auxiliary contact									
Emergency Power Off (EPO)	Yes									
Remote management	Available									
Mechanical characteristics										
Dimensions HxWxD (mm)	1370 x 414 x 628		1650 x 414 x 628	1370 x 414 x 628	1650 x 414 x 628	1370 x 414 x 628				1650 x 414 x 628
Net weight kg	202.5	265.5	327.5	273.5	344.5	115	136	134	158.5	222
Battery cabinet dimensions HxWxD (mm)	-	-	-	1370x 414x 628	1650x 414x 628	600x 800x1635				
Battery cabinet net weight (kg)	-	-	-	257	375	790	710	790		
Installable battery drawers	8	12	16	-	-	-	-	-	-	-
Ambient Conditions										
Operating temperature/humidity	0 - 40°C / 0 - 95% non condensing									
Protection rating	IP21									
Noise at 1 m from the unit (dBA)	58-62									
Conformity										
Certifications	EN 62040-1, EN 62040-2, EN 62040-3, EN 50171									
Services										
Installation	User executable, modular architecture with "Plug & Play" power modules and batteries									
Maintenance	Availability of optional services provided by the manufacturer									
Ease of management	Advanced diagnostic functions via the touch screen display									

* Standard configurations with 3-3 distribution (multi IN/OUT settings available upon request)

Keor MOD

UPS Modular three-phase double conversion VFI



3 104 80

Characteristics:

- Two cabinet types only (up to 124 kV and 250 kVA)
- Integrated backup for powers of up to 125 kVA
- UPS system capacity up to 600 kVA
- 10" touch screen with inward swivel option
- Reduced battery charging times
- Double conversion efficiency over 96.8%.
- Efficiency in ECO mode up to 99%
- Output power factor up to 1
- Modular redundancy in N+1 configuration.
- Noise controlled with intelligent fan management
- Multicoloured front LED bar
- Parallelable system with up to 24 modules
- Hot Swap and Plug and Play system
- Reduced battery charging times
- Decentralised bypass.
- Intelligence distributed between the modules

Item	UPS - empty power cabinets		Distribution	Weight (kg)
	Power (kVA)	Battery drawers socket-outlets		
3 104 80	25 - 125	from 2 to 5 battery drawers	3-3	256
3 104 81	25 - 250	-	3-3	233

Accessories

- 3 106 75 Output module 25 kVA
- 3 106 76 Kit of empty 6 battery block (to be used in sets of 4 per drawer)
- 3 106 77 Kit of 2 EMPTY battery drawers
- 3 106 78 Kit of 4 battery blocks (each 6 x 9 Ah batteries)
- 3 106 79 Kit of 4 battery blocks (each 6 x 11 Ah batteries)
- 3 109 62 Kit of 4 battery blocks (each 6x 9 Ah Long Life batteries)
- 3 104 84 Modular battery cabinet
- 3 109 89 Full conventional battery cabinet*
- 3 109 75 Parallel cable kit (1 kit for every 2 cabinets - length 6m)

* to be used in multiples of 2



NOTE: the stated backup times in minutes are estimated and may vary according to the load characteristics, operating conditions and environment.

For the choice of communication accessories, see the dedicated section of this catalogue.

n Configuration examples

UPS up to 125 kVA

- 25 Power: 25 kVA
- Back-up time: 48 min. when 100% charged
- 1 Power module
- 10 Battery drawers



UPS up to 250 kVA

- 50 Power: 50 kVA
- 2 Power modules



75

- Power: 75 kVA
- Back-up time: 11 min. when 100% charged
- 3 Power modules
- 10 Battery drawers



100

- Power: 100 kVA
- 4 Power modules



125

- Power: 125 kVA
- Back-up time: 5.2 min. when 100% charged
- 5 Power modules



250

- Power: 250 kVA
- 10 Power modules



Keor MOD

UPS Modular three-phase double conversion VFI

Characteristics

General Characteristics										
Nominal power (kVA)	25	50	75	100	125	150	175	200	225	250
Active power (kW)	25	50	75	100	125	150	175	200	225	250
Module power (kVA)	25									
Technology	On-Line double conversion VFI-SS-111									
Number of power modules	1	2	3	4	5	6	7	8	9	10
System	Modular, expandable and redundant UPS system									
Input specifications										
Input voltage	400V 3F+N+PE									
Input frequency	45-65 Hz (43,0 ÷ 68,4 Hz)									
Input voltage range	400V +15%/-20% - 230V +15%/-20%									
THD input current	< 3% (at full load)									
Compatibility with power supply units	Yes									
Input power factor	> 0.99									
Output Specifications										
Output voltage	380, 400, 415V									
Efficiency (power module)	Up to 96.8%									
System efficiency	Up to 96.5%									
Efficiency in Eco mode	99%									
Nominal output frequency	50/60 Hz selectable by the user ±2 % (standard), ±14 % (extended)									
Peak factor	3:1									
Waveform	Sinusoidal									
Output voltage tolerance	±1%									
THD output voltage	<0.5% with linear load, <1% with non-linear load									
Overload capacity	10 minutes at 125%, 60 seconds at 150%									
Bypass	Automatic bypass (static and electromechanical) and manual maintenance bypass									
Batteries										
Battery module	Plug & play									
Battery series type/voltage	VRLA - AGM 12 V, 9 Ah - 11 Ah									
Back-up time	Configurable									
Battery charger	Smart charge technology. 3-stage advanced cycle									
Independent battery configuration	Yes, maximum 5 sets of independent batteries (configurable as common or separate units)									
Communication and management										
Display	10" rotating colour touch screen									
Communication ports	2 x RS485 ports (one for external accessories), 11 input floating contacts, 8 output floating contacts, 1 network interface slot, USB host port									
Back feed protection	NC/NO auxiliary contact									
Emergency Power Off (EPO)	Yes									
Cold start push-button	Yes									
Remote control	Available									
Mechanical characteristics										
Height (mm)	1990									
Width (mm)	600									
Depth (mm)	1000									
Installed power modules	up to 5					up to 10				
Installable battery drawers	up to 10					—				
Net weight (kg)	256					233				
Ambient Conditions										
Operating temperature/humidity	0 - 40°C / 0 - 95% non condensing									
Protection rating	IP20									
Maximum audible noise at 1 m from the unit (dBA)	50-65									
Estimated content of circular economy derived materials	43%									
Recyclability rate calculated using the method described in technical report IEC/TR 62635*	74%									
Conformity										
Certifications	EN 62040-1, EN 62040-2, EN 62040-3									
Services										
Installation	Modular architecture with "Plug & Play" power modules and batteries									
Maintenance	Availability of optional services provided by the manufacturer									
Ease of management	Advanced diagnostic functions via the touch screen display									

* This value is based on data collected from a technological channel operating on an industrial basis. It does not pre-validate the effective use of this channel for end-of-life of this product.

CONVENTIONAL UPS

The **Legrand conventional UPS** units range in power from 10 kVA to 4.8 MVA and feature double conversion on-line technology, latest generation micro processors for accurate and constant control of all measurements, and a power factor correction (PFC) circuit.

Transformer-free technology electronics for high quality energy output with up to 96.4% efficiency.

These uninterruptible power supplies are the result of an accurate combination of technology and design and deliver high performance, reliability and ease of use and maintenance.

The high efficiency and low environmental impact make them the ideal solution in various application fields, often characterised by critical conditions such as hospitals, industries, transport and the various tertiary sectors.

The products that are part of this version are:

Keor Compact - Keor T Evo - Keor HP - Keor HPE - Keor XPE.



Keor XPE
from 600 kVA to 2.1 MVA



Keor Compact
from 10 to 20 kVA



Keor T Evo
from 10 to 60 kVA



Keor HP
from 100 to 800 kVA



Keor HPE
from 60 to 500 kVA

THE PERFECT
BALANCE BETWEEN
DIMENSIONS
AND **POWER**

The supplied internal batteries, with a capacity of up to 80 kVA, avoid additional costs for the purchase of external battery cabinets, help reduce the space occupied and simplify installation.



0.32 m²
(30 kVA, 20')



0.54 m²
(60 kVA, 14')



Range from 10 kVA to 4.8 MVA
High efficiency - up to 96%
Power factor =1



INTERNAL BATTERY FIXTURES

Excellent battery management

The advanced battery charge and management functions improve performance and operating life over time.

Front internal access

Legrand conventional UPS are designed to be installed and maintained from the front. All the manoeuvre switches and communication ports are installed on the front of the UPS. Ease of access to all parts subject to maintenance significantly reduces machine repair times.

CONVENTIONAL UPS

Parallelable system

It is possible to connect up to 6 identical power units in parallel depending on the power requirements. This achieves delivery of power levels of up to 4.8 MVA.

Scalability

The parallel connections of up to 6 UPS makes it possible to achieve different degrees of redundancy and maximum levels of continuity of service and safety of the system itself.

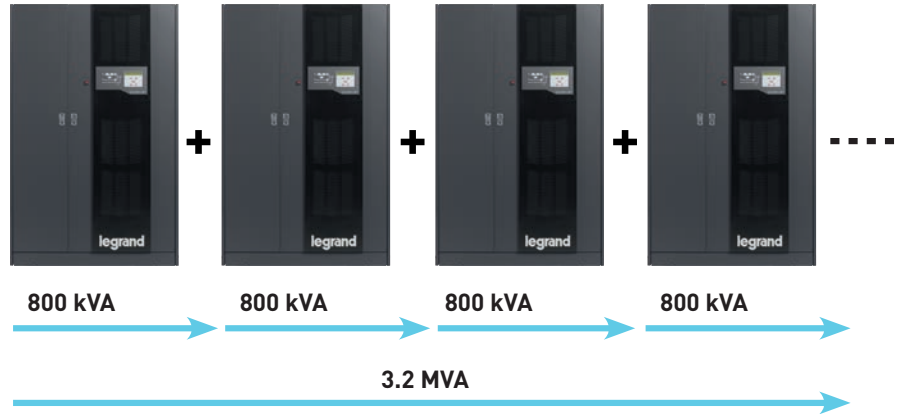

Keor HP

It is a sturdy UPS unit, equipped with an internal isolation transformer making it suitable for use in high electrical disturbance environments. Its nominal powers of from 100 to 800 kVA makes it ideal for high power applications in tertiary, hospital, industry and transportation sectors.



Keor XPE

It is a complete scalable UPS system based on 250 or 300 kVA power units that can be combined with others to achieve the required power level (up to 2.1 MVA) or create redundant configurations.

Keor XPE It is the ideal solution for Data Center and high power applications.



SPECIAL CARE FOR DESIGN

The elegance of the design and the skilful choice of materials complete the performance and reliability features of this series of UPS units.

The new user-friendly and intuitive touch-screen displays and the hexagonal pattern, also seen in the ventilation grids, enhance the product, combining technology and design.

Keor HPE

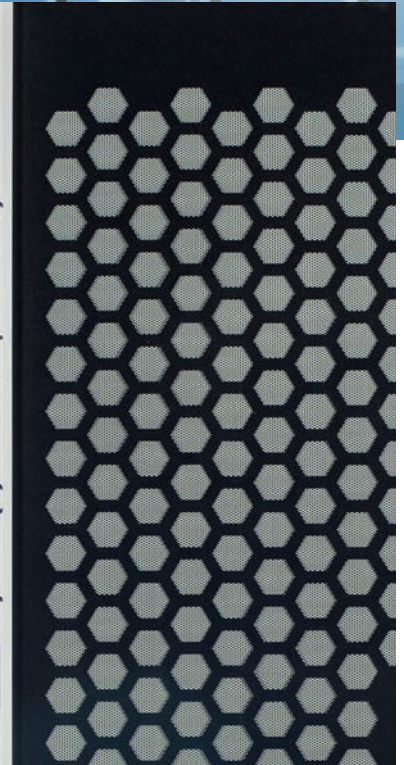

Keor T Evo

Its nominal powers of from 10 to 60 kVA provides a simple and compact solution for classic applications in tertiary, trade and industry sectors. Keor T Evo is scalable, parallelable and equipped with a display and multicoloured led bars that allow for swift UPS status checks.

Keor HPE

Keor HPE is the perfect solution for critical medium and large power applications and is available from 60 to 500 kVA versions.

Boasting attention to design and a smart display, it includes advanced battery charging and management features that guarantee top battery performance and maximum operating life.



Keor Compact

With a rated power of 10-15-20 kVA, this is an easy-to-install UPS with wheels and colour touchscreen with user-friendly graphics and navigation windows. Thanks to its small dimensions, Keor Compact is ideal for installation even in small technical rooms. Parallel connections for redundant configurations make this UPS the perfect solution also for critical applications.

Keor Compact

Conventional UPS - On-line three-phase double conversion VFI



3 111 00

Characteristics:

- PFC power-factor correction (input PF>0.99)
- 4.3" user friendly touch screen display
- Wide range of input voltages and frequencies
- Dual Input
- Cold Start
- Embedded backfeed protection
- Smart communication ports and SNMP management capability
- Parallelable system with up to 6 units
- Built-in battery for standard autonomy
- Extended backup time with battery cabinets
- Overload and short-circuit protection
- Powerful built-in loader
- RS232, dry contacts
- Compatibility with gensets
- Compact dimensions, lightweight and low noise
- Reduced footprint: 0.22 m²
- Wheels for ease of handling

Item	UPS			
	Nominal power (kVA)	Power active (kW)	Dimensions W x D x H (mm)	Weight (kg)
3 111 00	10	9	260 x 850 x 890	74
3 111 01	10	9	260 x 850 x 890	149
3 111 02	15	13.5	260 x 850 x 890	76
3 111 03	15	13.5	260 x 850 x 890	166
3 111 04	20	18	260 x 850 x 890	76
3 111 05	20	18	260 x 850 x 890	176

Accessories		Dimensions W x D x H (mm)
Description		
3 110 94	Empty Keor Compact battery cabinet	260 x 850 x 890
3 110 95	Keor Compact battery cabinet 10 kVA	260 x 850 x 890
3 110 96	Keor Compact battery cabinet 15 kVA	260 x 850 x 890
3 110 97	Keor Compact battery cabinet 20 kVA	260 x 850 x 890
3 110 98	Parallel system kit	
3 110 99	RS-485 MODBUS card	
3 111 06	Dry contact card	
3 110 86	Battery temperature probe	

Backup times table			
	Power (kVA)	Back-up time (min)	No. of battery cabinets*
311101	10	11	0
311101 + 1 x 311095	10	50	1
311101 + 2 x 311095	10	87	2
311101 + 3 x 311095	10	126	3
311103	15	7	0
311103 + 1 x 311096	15	40	1
311103 + 2 x 311096	15	67	2
311103 + 3 x 311096	15	99	3
311105	20	6	0
311105 + 1 x 311097	20	28	1
311105 + 2 x 311097	20	57	2
311105 + 3 x 311097	20	81	3

* 0 = UPS with internal batteries only.

n Dimensions (mm)

Keor Compact 10 - 15 - 20 kVA

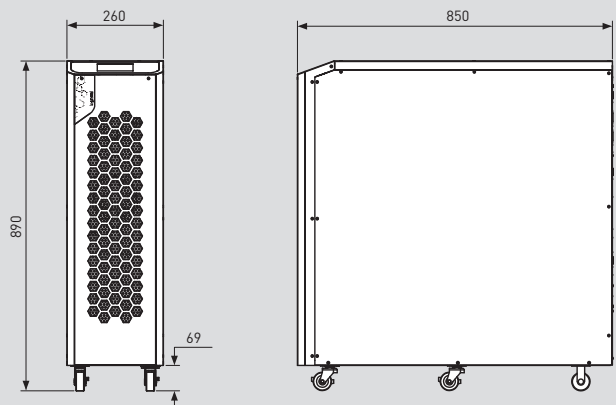

Battery cabinet

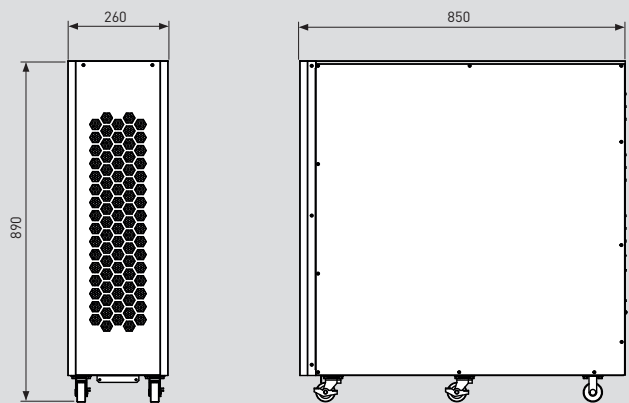

NOTE: the stated backup times in minutes are estimated and may vary according to the load characteristics, operating conditions and environment.

For the choice of communication accessories, see the dedicated section of this catalogue.

Keor Compact

Conventional UPS - On-line three-phase double conversion VFI

Characteristics

General Characteristics	Keor Compact 10	Keor Compact 15	Keor Compact 20
Nominal power (kVA)	10	15	20
Active power (kW)	9	13.5	18
Technology	On-Line Double Conversion VFI-SS-111		
Waveform	Sinusoidal		
Architecture	Stand Alone or Distributed with parallelable system with up to 6 units		
Efficiency	up to 95%		
Efficiency in ECO mode	up to 98.5%		
Input			
Nominal input voltage	400V (3Ph+N+PE)		
Nominal voltage (Ph-Ph)	±20% @100% load, -40/+20% @50% load		
Input frequency	40-70 Hz		
THD Input current	<3% at full load		
Dual Input	yes		
Compatibility with Power Supply Units	yes		
Input Power Factor	>0.99		
Output			
Output voltage	380, 400, 415V (3Ph+N+PE)		
Output voltage tolerance	± 1% static load		
Nominal output frequency	50 /60 Hz (Adjustable from the front panel)		
Output frequency tolerance	± 1 Hz / ± 3 Hz adjustable synch Mains for Bypass; ± 0.01% Free Run		
Peak factor	3:1		
THD Output voltage	<2% (with linear load), <5% (with non-linear load)		
Output power factor	0.9		
Overload capacity	60 min at 110%, 10 min at 125%; 1 min at 150%		
Bypass	Automatic and maintenance bypass		
Batteries			
Cold Start	yes		
Battery Type	VRLA		
Internal batteries	yes		
Communication and management			
Display	4.3" colour touch-screen display.		
Communication ports	RS232, Genset, 4 programmable relay contacts, RS485 (optional), network interface slot		
Backfeed protection	Integrated		
Alarms and signals	Alarms and audible warnings		
Emergency Power Off (EPO)	yes		
Remote control	available		
Mechanical characteristics			
Ventilation	Forced with fan from the front to the rear		
Maximum heat dissipation (100% of the W load, battery recharging)	600	900	1300
Colour	RAL9017 (black-cabinet) RAL9003 (white - control panel)		
Dimensions W x D x H (mm)	260 x 850 x 890		
Weight (without battery) (kg)	74	76	76
Weight (with batteries) (kg)	149	166	176
Ambient Conditions			
Operating temperature (°C)	0 - 40°C (recommended temperature for longer useful battery life: 20-25°C)		
Relative humidity	20-95% (not condensing)		
Protection rating	IP20		
Noise at 1 m from the unit (dBA)	< 52		
Estimated content of circular economy derived materials	≈ 39%		
Recyclability rate calculated using the method described in technical report IEC/TR 62635*	≈ 71%		
Conformity			
Certifications	IEC/EN 62040-1, IEC/EN 62040-2, IEC/EN 62040-3		

*This value is based on data collected from a technological channel operating on an industrial basis. It does not pre-validate the effective use of this channel for end-of-life of this product.

Keor T Evo

UPS - On-line three-phase double conversion VFI



Keor T Evo 10-30

Keor T Evo 10-30

Keor T Evo 40-60

Characteristics:

- Output from 10 to 60 kVA
- New Keor T Eco up to 20 kVA and power factor 1
- Three-phase UPS
- 3 level Switching technology
- IGBT Rectifier and inverter
- High efficiency
- Digital signal processor (DSP)
- High Input Power Factor Correction
- 3.5" TFT touch screen panel
- High output Power Factor
- Low input and output total harmonic distortion values (THD)
- Compatibility with gensets
- Parallelable system with up to 4 units
- Communication ports

Item	UPS		Dimensions (mm)	Weight (kg)
	Nominal power (kVA)	Back-up time (min.)		
3 110 20	10	0	1345 x 400 x 800	122
3 110 21	10	24	1345 x 400 x 800	261
3 110 22	10	37	1345 x 400 x 800	283
3 110 23	10	57	1650 x 400 x 800	426
3 110 24	15	0	1345 x 400 x 800	127
3 110 25	15	14	1345 x 400 x 800	268
3 110 26	15	22	1345 x 400 x 800	288
3 110 27	15	33	1650 x 400 x 800	431
3 110 28	20	0	1345 x 400 x 800	134
3 110 29	20	10	1345 x 400 x 800	275
3 110 30	20	15	1345 x 400 x 800	296
3 110 31	20	37	1650 x 400 x 800	477
3 110 32	30	0	1345 x 400 x 800	141
3 110 33	30	10	1345 x 400 x 800	302
3 110 34	30	13	1650 x 400 x 800	441
3 110 35	30	22	1650 x 400 x 800	484
3 110 36	40	0	1650 x 600 x 900	238
3 110 37	40	10	1650 x 600 x 900	538
3 110 38	40	15	1650 x 600 x 900	573
3 110 39	40	25	1650 x 600 x 900	740
3 110 40	60	0	1650 x 600 x 900	258
3 110 41	60	10	1650 x 600 x 900	590
3 110 42	60	15	1650 x 600 x 900	755

NOTE: the stated backup times in minutes are estimated and may vary according to the load characteristics, operating conditions and environment.

n Keor T Evo 10-15-20-30-40-60 with internal batteries

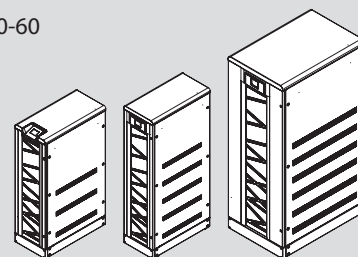

n Keor T Evo 10-15-20-30 with external battery cabinet

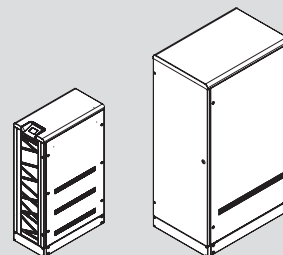

n Keor T Evo 40-60 with external battery cabinet

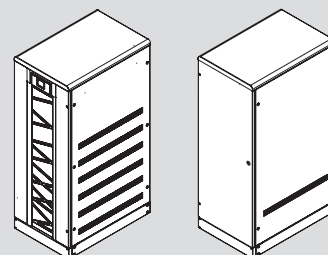

Item	Keor T 208 V			
	Nominal power (kVA)	Active Power (kW)	Dimensions H x W x D (mm)	Net weight (kg)
3 101 32	5	4,5	1345 x 400 x 800	118
3 101 33	7,5	6,75	1345 x 400 x 800	132
3 101 34	10	9	1345 x 400 x 800	134
3 102 78	15	13,5	1345 x 400 x 800	140
3 102 79	20	18	1650 x 600 x 900	255
3 102 96	30	27	1650 x 600 x 900	277
3 102 97	40	36	1650 x 600 x 800	315
3 102 98	50	45	1650 x 600 x 800	350
3 102 99	60	54	1650 x 793 x 800	430

Accessories

- 3 109 18 Battery cabinet empty (up to 60 blocks 55 Ah)
- 3 109 21 Internal cables kit for battery cabinet empty (for 60 blocks 55 Ah)
- 3 109 11 Battery drawers kit for Keor T Evo 10-30 kVA (up to 60 blocks 7-9 Ah)
- 3 109 12 Battery drawers kit for Keor T Evo 40-60 kVA (up to 60 blocks 7-9 Ah)
- 3 109 13 Internal battery cables kit for battery drawers Keor T Evo 10-30 kVA
- 3 109 14 Internal battery cables kit for battery drawers Keor T Evo 40-60 kVA
- 3 109 16 Kit for both in & ext battery connections for 1345H*
- 3 109 15 Parallel kit/UPS (PCB + 5 m cable)*
- 3 110 46 Parallel connection cable
- 3 110 47 Temperature Probe
- 3 109 87 Keor T Evo Battery Cabinet A
- 3 109 88 Keor T Evo Battery Cabinet B**

* Needed Only for 208 V version

** To be used in multiples of 2.



For the choice of communication accessories, see the dedicated section of this catalogue.

Keor T Evo

UPS - On-line three-phase double conversion VFI

n Characteristics

Model 3Ph 400V (380-400-415V) 3Ph	Keor T Evo 10	Keor T Evo 15	Keor T Evo 20	Keor T Evo 30	Keor T Evo 40	Keor T Evo 60				
Nominal power (kVA)	10	15	20	30	40	60				
Active power (kW)	10	15	20	30	40	60				
3Ph version 208V (200-208-220V)	Keor T 208V 5	Keor T 208V 7,5	Keor T 208V 10	Keor T 208V 15	Keor T 208V 20	Keor T 208V 30	Keor T 208V 40	Keor T 208V 50	Keor T 208V 60	
Nominal power (kVA)	5	7,5	10	15	20	30	40	50	60	
Active power (kW)	4,5	6,75	9	13,5	18	27	36	45	54	
General characteristics										
Technology	On-line double conversion VFI-SS-111									
Waveform	Sinusoidal									
Architecture	Stand alone or distributed parallel up to 6 units									
Input Characteristics										
Input voltage	400V (3Ph+N+PE)* / 200-208-220V (3Ph+N+PE)**									
Input frequency	45-65 Hz									
Input voltage range (Ph-Ph)	±20%* / ±15%**									
THD of input current	<5% at full load									
Compatibility with diesel generators	Yes									
Input power factor	>0.99									
Output characteristics										
Output voltage	380, 400, 415V (3Ph+N+PE)* / 200-208-220V (3Ph+N+PE)** (Adjustable from front panel)									
Efficiency	up to 96% *									
Efficiency in ECO mode	up to 98,5%									
Output frequency (nominal)	50 /60 Hz (Adjustable from front panel)									
Output frequency tolerance	±0,1%Synch with Mains; ±0,01% Free Run									
Crest factor	up to 3:1									
THD of output voltage	< 2% at full linear load									
Output power factor	1* / 0,9**									
Output voltage tolerance	± 1%									
Overload capability	10 min at 125%; 60 sec at 150%									
By-pass	Builtin automatic and maintenance bypass									
Batteries										
Battery type	VRLA – AGM Maintenance free									
Internal batteries	Yes				No					
Battery test	Yes Automatic or Manual									
Battery recharge profile	IU (DIN41773)									
Communication and management										
LCD Display	Touch screen, led bar status, live synoptic view for real time									
Communication Ports	RS232, RS485, GenSet, Programmable 4 relay contacts, ModBus									
Back feed protection	Internal back feed protection device is standard									
Audible alarm	Acoustic alarms and warnings									
Net interface slot	optional SNMP card									
Emergency Power Off (EPO)	Yes									
Remote management	Available									
Physical characteristics										
Dimensions H x W x D (mm)	1345/1650 x 400 x 800* 1345 x 400 x 800**			1650 x 600 x 900		1650 x 600 x 980		1650 x 793 x 800		
Dimensions battery cabinet H x W x D (mm)	1650 x 800 x 900									
Ambient conditions										
Operating temperature (°C)	0-40									
Relative humidity (%)	20-95% not condensing									
Protection index	IP20									
Noise at 1 m (dBA)	< 58			< 60			< 65			
Estimated content of circular economy derived materials	39%									
Recyclability rate calculated using the method described in technical report IEC/TR 62635***	71%									
Compliance										
Reference product standards	EN 62040-1, EN 62040-2, EN 62040-3									

* for 3Ph 400V Version

** for 3Ph 208V Version

*** This value is based on data collected from a technological channel operating on an industrial basis. It does not pre-validate the effective use of this channel for end-of-life of this product.

Keor HP

Conventional UPS - On-line three-phase double conversion VFI



Keor HP 100



Keor HP 400

Characteristics:

- Power from 100 to 800 kVA
- Three-phase UPS
- Rectifier IGBT
- High efficiency
- Digital signal processor (DSP)
- High Input Power Factor Correction
- High output Power Factor
- Battery recharge with temperature compensation
- Output isolation transformer
- Low input and output total harmonic distortion values (THD)
- Compatibility with gensets
- Parallelable system with up to 6 units
- Communication ports
- Optimised cooling system

Model	UPS (without batteries)			
	Power nominal kVA	Active power kW	Dimensions H x W x D (mm)	Net weight (kg)
Keor HP 100	100	90	1670 x 815 x 825	625
Keor HP 125	125	112.5	1670 x 815 x 825	660
Keor HP 160	160	144	1670 x 815 x 825	715
Keor HP 200	200	180	1905 x 1220 x 870	970
Keor HP 250	250	225	1905 x 1220 x 870	1090
Keor HP 300	300	270	1905 x 1220 x 870	1170
Keor HP 400	400	360	1920 x 1990 x 965	1820
Keor HP 500	500	450	2020 x 2440 x 950	2220
Keor HP 600	600	540	2020 x 2440 x 950	2400
Keor HP 800	800	720	1920 x 3640 x 950	3600

Accessories

- 3 109 89 Keo HP battery cabinet full*
- Empty battery cabinet with connections and protections
- 10 year batteries in cabinets
- (1) Isolation transformer
- External bypass
- Remote control panel

(1) Attachments to be defined during the order phase.

* to be used in multiples of 2



n Keor HP 100-125-160

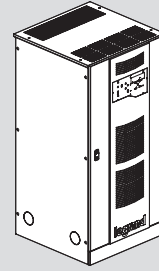

n Keor HP 200-250-300

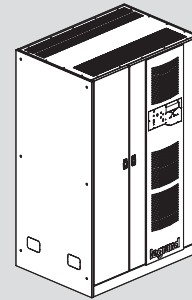

n Keor HP 400

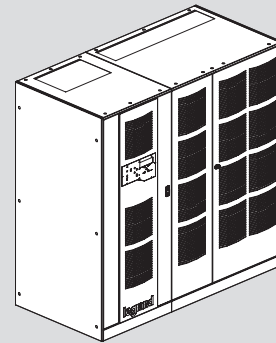

n Keor HP 500-600

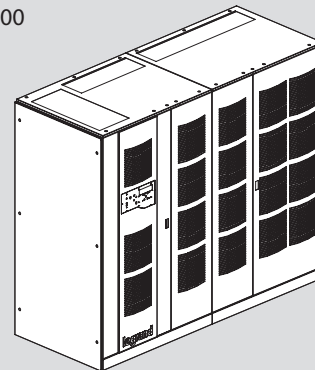

n Keor HP 800

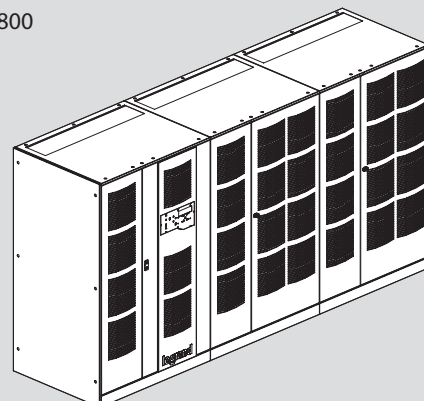

Keor HP

Conventional UPS - On-line three-phase double conversion VFI

Characteristics

General Characteristics	100	125	160	200	250	300	400	500	600	800
Nominal power (VA)	100	125	160	200	250	300	400	500	600	800
Active power (W)	90	112.5	144	180	225	270	360	450	540	720
Technology	On-Line Double Conversion VFI-SS-111									
Waveform	Sinusoidal									
UPS Architecture	Conventional UPS parallel operations with up to 6 units									
Input										
Input voltage	400V -20% / +15% 3Ph+N									
Input frequency	50-60 Hz ± 10% autosensing									
THD Input current	<3%									
Compatibility with genset	Configurable to achieve synchronisation between the input frequencies and output frequencies, also for wider frequency ranges									
Input power factor	>0.99									
Output										
Output voltage	380, 400, 415 V 3Ph+N selectable									
Efficiency	Up to 95%									
Output frequency (nominal)	50 /60 Hz selectable ± 0,001%									
Peak factor	3:1									
THD of Output voltage	<5% (with non-linear load)									
Output voltage tolerance	± 1% (with balanced load)									
Overload capacity	10 minutes at 125%, 1 minute at 150%, 10 seconds at 200%									
Efficiency in Eco Mode	98%					>98%				
Bypass	Automatic and maintenance bypass					Automatic bypass (optional maintenance bypass)				
Batteries										
Backup time extension	Yes with additional battery cabinets									
Battery series type/voltage	VRLA- AGM Lead Acid, sealed, maintenance-free									
Battery test	Automatic or manual									
Battery charger	IU (DIN41773)									
Communication and management										
LCD Display	LCD and LED display to monitor UPS status in real-time 4 menu navigation buttons									
Communication ports	RS232, network interface slot or floating contact card, RS485 (optional)									
Alarms and signals	Configurable audible alarms and warnings									
Configuration settings	By expert operators, self-configurable firmware									
Emergency Power Off (EPO)	Yes									
Remote control	Available									
Battery temperature sensor	Yes									
Mechanical characteristics										
Dimensions (HxWxD) (mm)	1670 x 815 x 825			1905 x 1220 x 855			1920 x 1990 x 965	2020 x 2440 x 950	2020 x 2440 x 950	1920 x 3640 x 950
Net weight (kg)	625	660	715	970	1090	1170	1820	2220	2400	3600
Battery cabinet dimensions (H x W x D) (mm)	1900x1400x830 (50 batteries) 1900x2800x830 (100 batteries)			1900x1400x860 (50 batteries) 1900x2800x860 (100 batteries)			1900 x 2800 x 860 (100 batteries)			
Ambient conditions										
Operating temperature (°C)	0 – 40									
Relative humidity (%)	<95% non condensing									
Protection rating	IP20									
Noise at 1 m from the unit (dBA)	< 60					< 62				
Estimated content of circular economy derived materials	11%									
Recyclability rate calculated using the method described in technical report IEC/TR 62635*	69%									
Conformity										
Certifications	EN 62040-1, EN 62040-2, EN 62040-3									

*This value is based on data collected from a technological channel operating on an industrial basis. It does not pre-validate the effective use of this channel for end-of-life of this product.

Keor HPE

Conventional UPS - On-line three-phase double conversion VFI



Characteristics:

- Power from 60 to 500 kVA
- Three-phase UPS
- IGBT Rectifier
- High efficiency
- Digital signal processor (DSP)
- High Input Power Factor Correction (PFC)
- Output Power Factor 1
- Battery recharge, dynamic, intermittent with temperature compensation
- Low input and output total harmonic distortion values (THD)
- Compatibility with gensets
- Parallel operations with up to 6 units
- Communication ports
- Optimised cooling system

Model	UPS		Back-up time (min)	Dimensions H x W x D (mm)	Net weight (kg)
	Nominal power (kVA)	Active power (kW)			
3 110 87	60	60	0	1500 x 560 x 940	225
3 110 88	60	60	5	1500 x 560 x 940	525
3 110 89	60	60	10	1500 x 560 x 940	675
3 110 90	80	80	0	1500 x 560 x 940	250
3 110 91	80	80	5	1500 x 560 x 940	700
9 605 69	100	100	-	1800 x 560 x 940	320
9 605 70	125	125	-	1800 x 560 x 940	360
9 605 71	160	160	-	1800 x 560 x 940	380
9 605 72	200	200	-	1978 x 880 x 970	720
9 535 00	250	250	-	1978 x 880 x 970	850
9 535 01	300	300	-	1978 x 880 x 970	900
9 535 02	400	400	-	1978 x 1430 x 970	1080
9 535 03	500	500	-	1978 x 1430 x 970	1250

Accessories

9 535 16	Parallel interface
9 535 17	Interface for MODBUS RS485
3 109 87	Keor HPE Full Battery Cabinet
3 109 88	Keor HPE Full Battery Cabinet*
-	Empty battery cabinets

Options

Consult US

- Synchronism kit on two UPS**
- Synchronism kit on two parallel UPS**
- Isolation transformer
- 7" touch display (for Keor HPE 60-160)
- IP 21 Kit
- Common battery kits



* to be used in multiples of 2

** to create two independent synchronous electrical lines (typical in Tier III, IV systems)

NOTE: the stated backup times in minutes are estimated and may vary according to the load characteristics, operating conditions and environment.

For the choice of communication accessories, see the dedicated section of this catalogue.

n Keor HPE 60-80 kVA

n Keor HPE 100-125-160 kVA

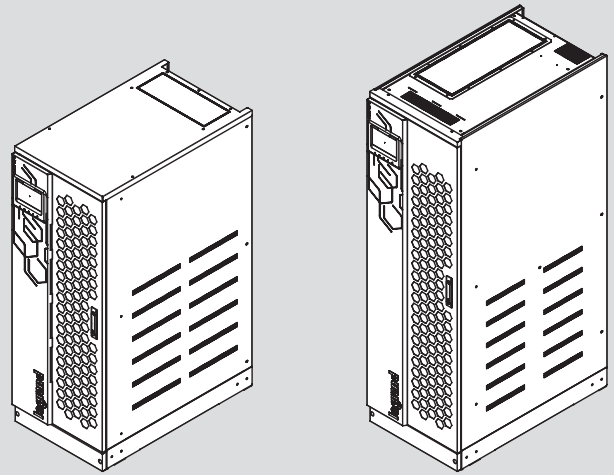

n Keor HPE 200-250-300 kVA

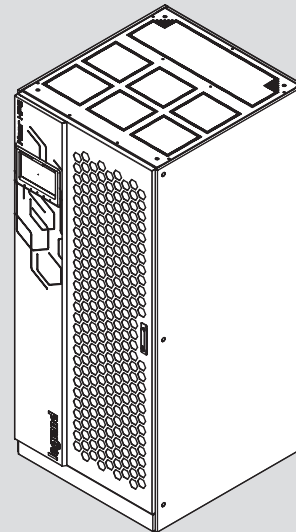

n Keor HPE 400-500 kVA

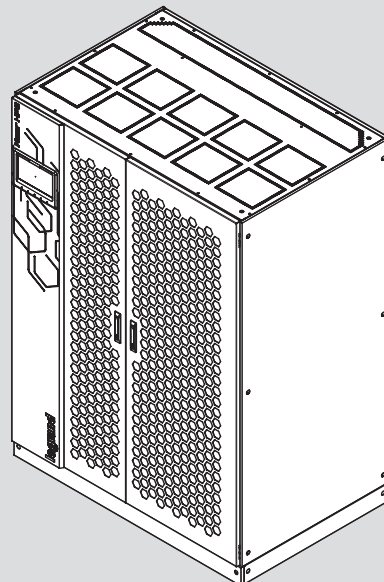

Keor HPE

Conventional UPS - On-line three-phase double conversion VFI

Characteristics

General Characteristics	60	80	100	125	160	200	250	300	400	500
Nominal power (kVA)	60	80	100	125	160	200	250	300	400	500
Active power (kW)	60	80	100	125	160	200	250	300	400	500
Technology	On-Line Double Conversion VFI-SS-111									
Waveform	Sinusoidal									
UPS Architecture	Conventional UPS parallel operations with up to 6 units									
Input										
Input voltage	380-400-415 V 3Ph+N									
Input frequency	50-60 Hz (45÷65Hz)									
Input voltage range	400 V -20% / + 15%									
THD Input current	< 3%									
Compatibility with genset	Configurable to achieve synchronisation between the input frequencies and output frequencies, also for wider frequency ranges									
Input power factor	> 0.99									
Output										
Output voltage	380, 400, 415 V 3Ph+N									
Efficiency	Up to 95%	Up to 96%					Up to 96.4%			
Nominal output frequency	50 /60 Hz									
Peak factor	3:1									
THD of Output voltage	<1% (with linear load) <5% (with non-linear load)									
Output voltage tolerance	± 1% (with balanced load)									
Overload capacity	10 minutes at 125%, 30 seconds at 150% 0,1 seconds >150%					10 minutes at 110%, 5 minutes at 125%, 30 seconds at 150% 0.1 seconds >150%				
Efficiency in Eco Mode	> 98%									
Bypass	Automatic and maintenance bypass									
Batteries										
Internal batteries	yes	yes	-	-	-	-	-	-	-	-
Backup time extension	Yes with additional battery cabinets									
Battery series type	VRLA- AGM Lead Acid, sealed, maintenance-free									
Battery test	Automatic or manual									
Battery charger	IU (DIN41773)									
Communication and management										
LCD Display	LCD and LED display to monitor UPS status in real-time 4 menu navigation buttons (optional 7" touch screen)					10" touch screen display to monitor UPS status in real-time				
Communication ports	relay contact card, RS232, USB, RS485 (optional), network interface slot									
Alarms and signals	Configurable audible alarms and warnings									
Emergency Power Off (EPO)	yes									
Remote control	available									
Battery temperature sensor	yes									
Mechanical characteristics										
Dimensions (HxWxD) (mm)	1500 x 560 x 940		1800 x 560 x 940			1978 x 880 x 970			1978 x 1430 x 970	
Net weight (kg)	225	250	320	360	380	720	850	900	1080	1250
Ambient conditions										
Operating temperature (°C)	0 – 40									
Relative humidity (%)	< 95% non condensing									
Protection rating	IP20									
Noise at 1 m from the unit (dBA)	< 60					< 65			< 72dB	
Estimated content of circular economy derived materials	17%									
Recyclability rate calculated using the method described in technical report IEC/TR 62635*	56%									
Conformity										
Certifications	EN 62040-1, EN 62040-2, EN 62040-3									

*This value is based on data collected from a technological channel operating on an industrial basis. It does not pre-validate the effective use of this channel for end-of-life of this product.

Keor XPE

Scalable UPS - Online three-phase double conversion VFI



In/Out-Bypass Module



Power unit
Up to 7 units



Distribution cabinet
(optional)

Characteristics

- On-Line Double Conversion VFI SS 111
- 3-level IGBT technology - Transformer Free
- Output power factor = 1 without downgrading up to 40°C in continuous operation mode (VFI)
- Configurable internal redundancy (N + 1 or N + X).
- Hot maintainable modules
- Hot scalability (optional)
- Up to 96,4% efficiency VFI even at low power
- ECO mode up to 99% of efficiency.
- Built-in backfeed protection
- Automatic battery test feature.
- Genset compatibility with Adaptive Ramp-in
- Compact design.
- Low audible noise.
- Synch 2N

Components	UPS		Dimensions HxWxD (mm)
POWER UNIT	250	250	880x979x2100
POWER UNIT	300	300	880x979x2100
IOBM 600	600	600	1002x979x2100
IOBM 750	750	750	1450x979x2100
IOBM 900-1000	1000	1000	1500x979x2100
IOBM 1200-1500	1500	1500	1850x1000x2100
IOBM 1800-2100	2100	2100	2300x1200x2100
DISTRIBUTION CABINET*	2 x 300 kW lines		800x979x2100
DISTRIBUTION CABINET*	3 x 300 kW lines		800x979x2100
DISTRIBUTION CABINET*	4 x 300 kW lines		800x979x2100
DISTRIBUTION CABINET*	5 x 300 kW lines		800x979x2100

* for hot-swapping

Options

Consult us

- Description
- Future Scalability
 - Hot Scalability
 - Input Line: Dual/Single
 - Connection Entrance: Bottom/Top
 - Connection Type: Cable/Busbar
 - Grounding System: TNC/TNS
 - Icw limitation kit
 - Battery set: Centralized/Distributed
 - Central or side IOBM
 - Special distribution kits for customised cabinet layouts
 - IP21 Kit

Accessories

Consult us

- Description
- Battery cabinets
 - Battery switch fuse box
 - Synchronisation box
 - MODBUS RS485 card
 - Ethernet card with network interface

Please contact Legrand for further details on the configurations and accessories.

n Dimensions

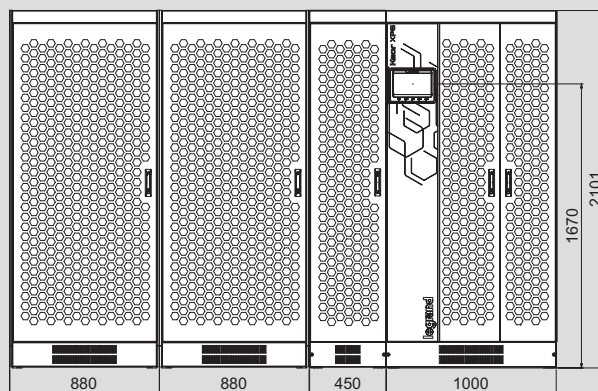
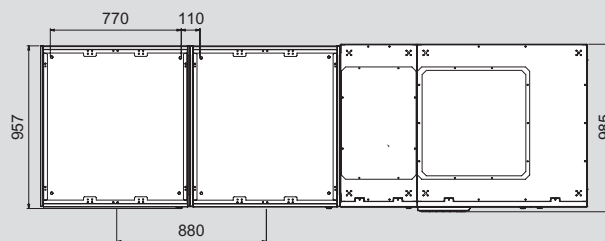

Keor XPE

Scalable UPS - Online three-phase double conversion VFI

Characteristics

General Characteristics	IOBM 600	IOBM 750	IOBM 900	IOBM 1000	IOBM 1200	IOBM 1250	IOBM 1500	IOBM 1800	IOBM 2100
Nominal power (kVA)	600	750	900	1000	1200	1250	1500	1800	2100
Power Unit power (kVA)	300	250	300	250	300	250	300	300	300
Number of power units (+1 redundant)	2+1	3+1	3+1	4+1	4+1	5+1	5+1	6+1	7
Technology	On-Line Double Conversion VFI-SS-111								
Architecture	Decentralised logic, centralised static bypass, scalable, redundant, hot-swap service (optional hot plug)								
Input									
Input voltage	400 Vac three-phase (rectifier), 380/400/415 Vac three-phase (Bypass)								
Input frequency	50/60 Hz; range 45-65 Hz								
Input Voltage Range (Ph-Ph)	-20%, +15% (rectifier); ±10% (bypass)								
THD Input current	< 3%								
Compatibility with genset	Yes								
Input power factor	> 0.99								
Output									
Output voltage	380, 400, 415V (3Ph+N+PE)								
Online Efficiency	up to 96.4%								
Efficiency in GREEN Mode	up to 99%								
Nominal output frequency	50 /60 Hz (Adjustable from the front panel)								
Peak factor	up to 3:1								
THD of Output voltage	< 1% with linear load								
Output Power Factor	0.7 which reaches 0.5 in delay without downgrading								
Output voltage adjustment VFI	Static ± 1%; Dynamic Class 1 IEC/EN 62040-3								
Overload capacity	Inverter: 125% for 5 min, 150% for 30 sec;								
Bypass									
Type	Automatic static without interruption, manual bypass optional								
Input voltage	380-400-415V ± 20%; (3Ph+N+PE)								
Input frequency	50-60Hz ± 10%								
Rated current (A)	870	1090	1304	1450	1739	1810	2175	2609	3044
Max. LCW	50 kA IEC 62040-1 standard (100 kA optional)								
Batteries									
Battery type	VRLA, NiCd, Li-Ion								
Connecting the battery	Distributed or centralised								
Communication and management									
LCD Display	10" Touch screen, 1024x600 pixels								
Communication ports	RS232, USB, RS485, network interface slot								
Input and auxiliary contact signal ports.	Remote Emergency Power Off (REPO), diesel mode, temperature probe, battery circuit breaker. External automatic switch auxiliary contact: battery, external maintenance bypass, remote output transfer in bypass mode								
Output signal ports	5 dry contacts, external BackFeed								
Mechanical characteristics									
Connection lines	Wired TNC or TNS 3PH output, rectifier and bypass (single input optional)								
Input and connection type	Bottom (top as optional), cable (busbar as optional)								
Colour	RAL 9003 (white) on the front panel of the IOBM; RAL 9005 (black) body and side panels of all cabinets								
UPS dimensions WxDxH (mm)*	2770x970x2100	4090x970x2100	4970x980x2100	5370x980x2100	6250x980x2100	7580x1200x2100	8460x1200x2100		
UPS weight (kg)*	2250	3150	3300	4000	4250	4900	5200	6400	7300
Ambient conditions									
Operating temperature (°C)	0 - 40 °C (recommended temperature for longer useful battery life: 20-25°C)								
Relative humidity (%)	20-95% (non condensing)								
Protection rating	IP20 (IP21 Optional)								
Noise at 1 m from the unit (dBA)	< 65								
Estimated content of circular economy derived materials	≈ 20%								
Recyclability rate calculated using the method described in technical report IEC/TR 62635*	≈ 60%								
Conformity									
Certifications	IEC/EN 62040-1, IEC/EN 62040-2, IEC/EN 62040-3								

* Weights and dimensions depend on the configuration chosen and refer to the complete basic system (no redundancy, no hot swapping).

**This value is based on data collected from a technological channel operating on an industrial basis. It does not pre-validate the effective use of this channel for end-of-life of this product.



BATTERY CABINET

For all three-phase UPS.



Battery cabinet

For all three-phase UPS



3 106 57 up to 20 batteries 105 Ah



3 109 82 up to 62 batteries 105 Ah

Universal battery cabinets for all three-phase Legrand UPS from 10kVA up to 800kVA power range. The Battery cabinet is designed to house standard VRLA Batteries of capacity range from 24Ah to 105Ah (C10). The battery cabinets are available in 5 different mechanical dimensions, are able to contain various combination of Batteries, up to maximum 63 blocks, connected in series and parallel, with positive, negative and middle point poles and with max DC voltage of 800Vdc.

Item	Empty battery cabinet*				UPS Compatibility
	Cabinet Dimensions (mm)	TOT Weight (kg)	Indicative Battery Capacity (Ah)	Standard No. Of Blocks	
3 106 26	800x900x1420	213	24	60	Keor T
3 106 27	800x900x1420	214	24	40	Trimod HE
3 106 55	800x900x1420	213	55	20	Trimod HE
3 106 56	800x900x1420	215	70-93	20	Trimod HE
3 106 57	800x900x1420	215	105	20	Trimod HE
3 106 58	800x900x1900	253	24	21	Archimod HE
3 106 59	800x900x1900	253	24	60-62	Keor HPE
3 106 70	800x900x1900	254	24	42	Archimod HE
3 106 71	800x900x1900	253	24	63	Archimod HE
3 106 72	800x900x1900	253	41	21	Archimod HE
3 106 73	800x900x1900	253	41	60-62	Keor HPE / Keor T
3 106 74	800x900x1900	254	41	42	Archimod HE
3 109 40	800x900x1900	253	55	21	Archimod HE
3 109 41	800x900x1900	254	55	42	Archimod/Trimod HE
3 109 42	800x900x1900	255	70-93	21	Archimod HE
3 109 43	800x900x1900	255	105	21	Archimod HE
3 109 44	1200x900x1900	333	55	60-62	Keor HPE / Keor T
3 109 65	1200x900x1900	335	70-93	50-52	Keor HP
3 109 66	1200x900x1900	336	70-93	40-42	Archimod/Trimod HE
3 109 67	1200x900x1900	335	105	50-52	Keor HP
3 109 68	1200x900x1900	336	105	42	Archimod/Trimod HE
3 109 80	1400x900x1900	385	70-93	60-62	Keor HPE / Keor T
3 109 81	1400x900x1900	385	70-93	60	Trimod HE
3 109 82	1400x900x1900	385	105	60-62	Keor HPE / Keor T
3 109 83	1400x900x1900	385	105	60	Trimod HE
3 109 84	1400x900x2080	415	105	21	Archimod HE 240/480
3 109 85	1400x900x2080	416	105	42	Archimod HE 240/480
3 109 86	1400x900x2080	415	105	63	Archimod HE 240/480

* in the cabinet are included Fuse Holder Switch and Fuses. Batteries not included

Characteristics

General characteristics	
Nominal Voltage	800 Vdc
Battery segregation	Internal panel in Polycarbonate
Switches and protection access	Internal bottom front side
Disconnection and protection devices *	Fuse Holders Switch with NH fast fuses (sized accordingly with Battery Power)
Fuse holder Open/Close signal*	Auxiliary Micro Switch
Cable Entrance	bottom sides (both left and right)
Cable connections	On Fuse holder terminals
Max Cable side entrance	3x 150mm ²
Cabinet Access	Front door with key lock and removable sides and rear panels
Shelter Bent Metal Sheet Thickness	20/10
Shelves Bent Metal Sheet Thickness	30/10
Protection Degrees	IP20 (Optional IP21)
Colour	RAL 7016
Standard	IEC-EN 62040-1



COMMUNICATION ACCESSORIES AND SOFTWARE

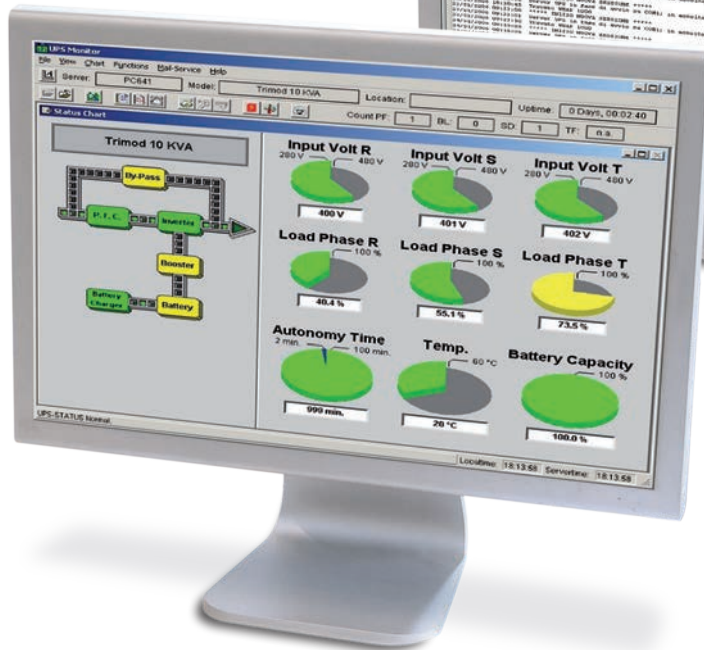
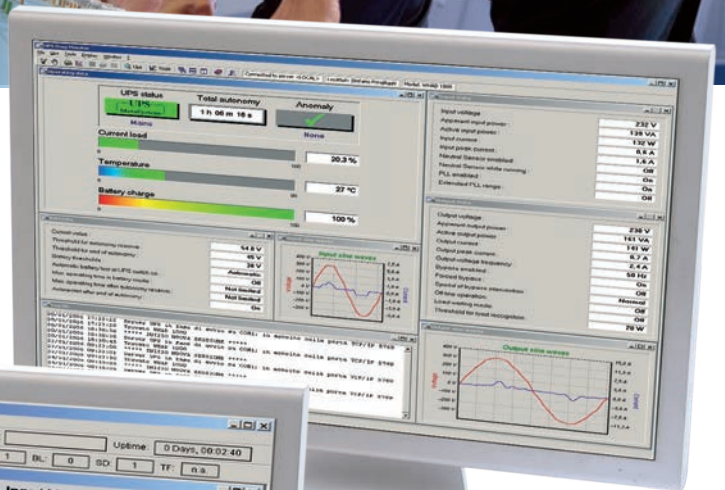

Accessories

network interfaces



Model	Item	Network interface CS141
		<p>Network interfaces for UPS management do not require external software; in fact, they are equipped with their own proprietary operating system which is able to continuously control the UPS operations and handle multiple events (power failure, overload, bypass, anomaly, etc.) and consequently to carry out a series of actions, such as, for instance:</p> <ul style="list-style-type: none"> - Saving of event logs complete with date and time - Saving of main operating data trends complete with date and time - Sending of emails - Performance of scheduled actions - Display of pop-up messages, shutdown operations and custom commands on remote computers (it is necessary that the RCCMD software agent is installed on these computers) - Switching ON and OFF the UPS - Sending of "Wake on LAN (WOL) " signals - SNMP protocol support - Sending of SNMP trap messages - Data display and configuration via internet browser - Firmware downloadable free of charge from the Internet - 10/100Mbit Base-T Ethernet connection (half-duplex and full-duplex) with self-recognition function - DHCP function - No. 1 RCCMD license included <p>Available in both internal and external versions, the internal version is housed in a dedicated UPS slot. The professional versions have an additional RS232 communication port. The industrial versions have an additional RS485 communication port.</p>
CS141 SK	3 109 30	Professional network interface internal version (slot)
CS141B SK	3 109 31	Standard network interface internal version (slot)
CS141	3 109 32	Professional network interface external version
CS141B	3 109 33	Standard network interface external version
CS141M	3 109 34	Industrial network interface external version
CS141M SK	3 109 35	Industrial network interface internal version (slot)
		Network interface CS101
CS101	3 109 38	Network interface internal version (slot) compatible with Daker DK, Daker DK Plus, Keor S, Keor LP, Keor Line RT, Keor T, Keor T Evo

CS141 Characteristics

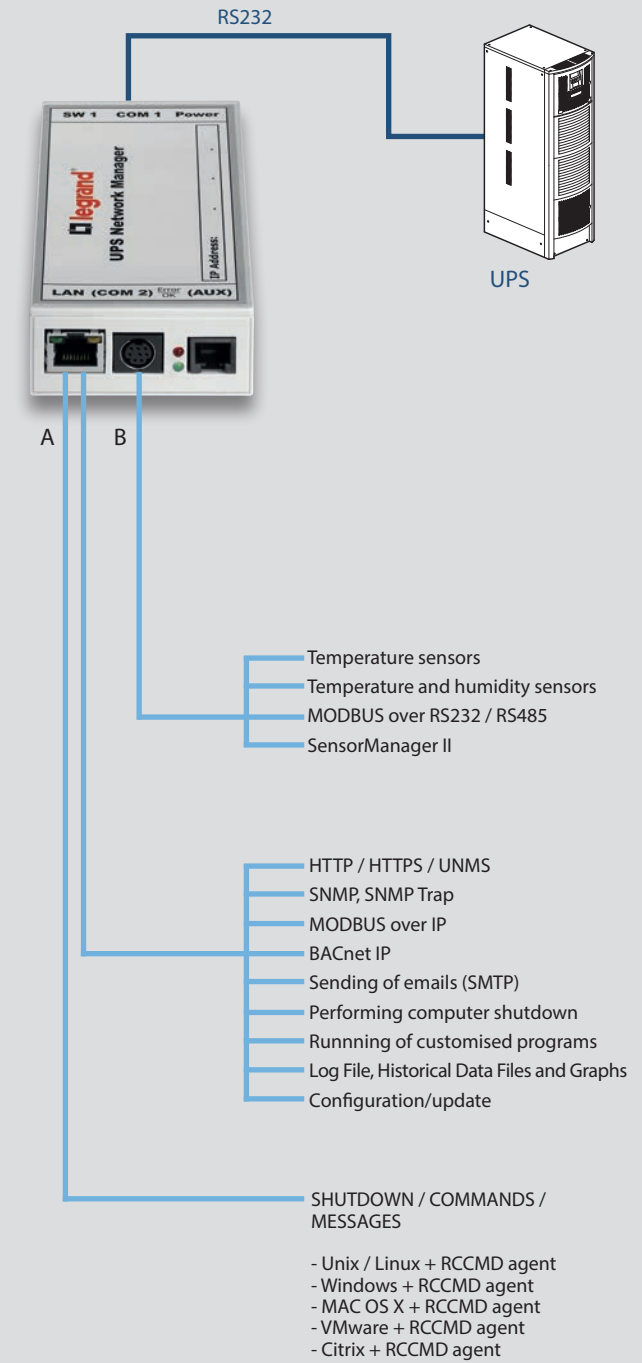

Model	A	B
CS141B	X	
CS141B SK	X	
CS141	X	X
CS141 SK	X	X
CS141M	X	X*
CS141M SK	X	X*

*modbus over RS485 only.

Accessories

sensors and various accessories



Model	Item	Sensors
SM_T_COM	3 108 97	Temperature sensor for direct connection to the COM2 of the CS141, CS141 SK interfaces. Cannot be used with SensorManager II.
SM_T_H_COM	3 108 98	Combined temperature and humidity sensor for direct connection to the COM2 of the CS141, CS141 SK interfaces. Cannot be used with SensorManager II.
SensorManager II	3 108 99	Ambient sensor manager: it connects to the COM2 of the CS141, CS141 SK interfaces and manages up to 8 analogue inputs, 4 digital inputs and 4 digital outputs. The configuration is managed directly by the CS141 interfaces (PROFESSIONAL versions) described above. The "Scale Divisor" and "offset" configuration functions allow the SensorManager II to be used with any analogue device (see characteristics). No. 1 "SM_T" temperature sensor included.
SM_T	3 109 00	Temperature sensor for exclusive use with SensorManager II. It allows the connection of another "SM_T" sensor via a designated connector.
SM_T_H	3 109 01	Combined temperature and humidity sensor for exclusive use with SensorManager II.
Port sensor	3 109 02	It consists of a reed switch and a magnet. Compatible exclusively with SensorManager II.
SM_flash	3 109 03	Flashing light signal. Compatible exclusively with SensorManager II.

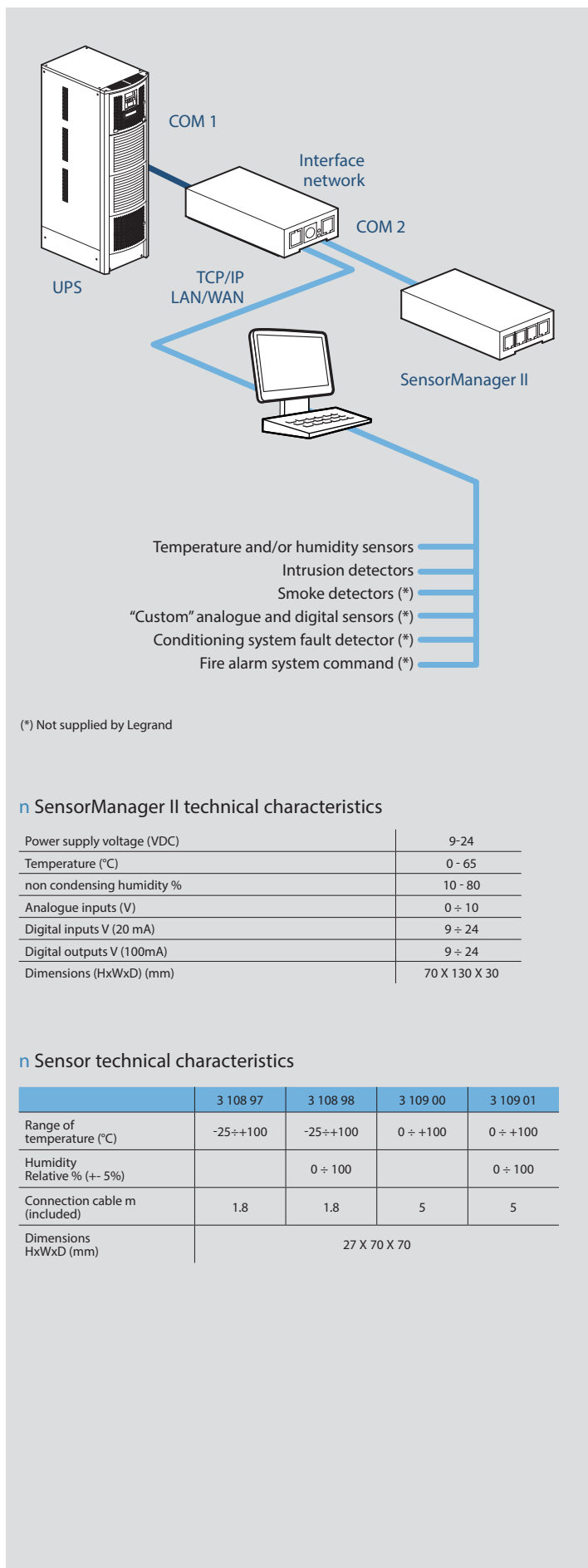

Accessories

management software

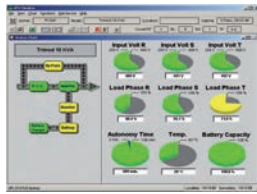
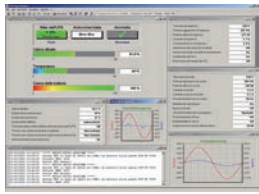

Model	Item	Software
		Description
UPS Communicator	downloadable	Software consisting of a set of applications designed to continuously monitor the UPS unit operations and guarantee the integrity of the operating systems of the computers powered by the same UPS unit. Complete with agent for executing commands on remote computers (RS System).
UPS Management Software	3 108 79	Software consisting of a set of applications designed to continuously monitor the UPS unit operations and guarantee the integrity of the operating systems of the computers powered by the same UPS unit. To be completed with agent for executing commands on remote computers (RCCMD). 1 RCCMD licence included.
UPS Management Software	3 108 80	Software consisting of a set of applications designed to continuously monitor the UPS unit operations and guarantee the integrity of the operating systems of the computers powered by the same UPS unit. RS232/USB converter included. To be completed with agent for executing commands on remote computers (RCCMD). 1 RCCMD licence included.
RCCMD		Software that enables a computer to receive and execute, by means of a TCP/IP protocol, all remote commands transmitted by the UPS Management Software and any CS141 network interface. An RCCMD license is required for each controlled computer. Only the licences are supplied: the software is downloadable from the Internet.
RCCMD	3 108 85	Multi OS RCCMD licence
RCCMD	3 108 86	Pack of 5 multi OS RCCMD licenses
RCCMD	3 108 87	Pack of 10 multi OS RCCMD licenses
RCCMD	3 108 88	Pack of 25 multi OS RCCMD licenses
RCCMD	3 108 89	Pack of 50 multi OS RCCMD licenses
RCCMD	3 108 90	RCCMD licence for AS/400 (minimum release: V5R3M0)
UNMS		A "WEB based" application which is able to continuously monitor the status of all UPS units via the UPS management systems and TCP/IP protocol.
UNMS	3 108 91	UNMS licence for 25 UPS
UNMS	3 108 92	UNMS licence for 50 UPS
UNMS	3 108 93	UNMS licence for 150 UPS

Examples of the types of management and communication that can be created using the software and hardware

Local protection

Protects one station only (PC or server) and must be installed at a distance of less than 12 metres (RS232) or 5 metres (USB).

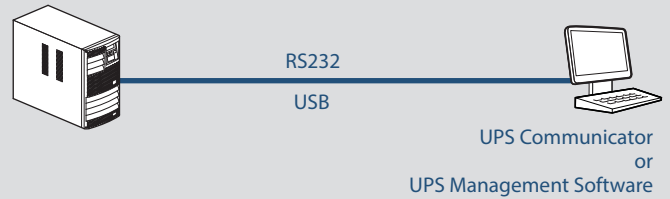

Extended local protection

Protects multiple stations (PC or server) but all must be dependent on the COMPUTER that controls the UPS.

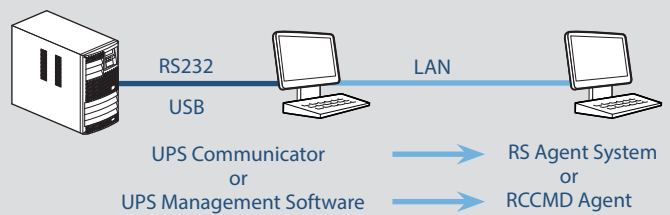

Extended local protection

Enables control of all the stations that can be managed by the UPS network interface. The coordination of the entire system can be monitored and controlled by each authorised user.

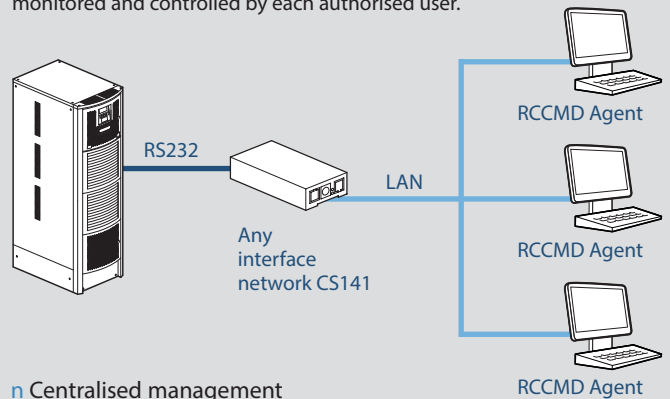

Centralised management

Using the UNMS supervision software, it is possible to control all the UPS connected to a TCP/IP network via any network interface that supports SNMP v1 or v2 protocols.

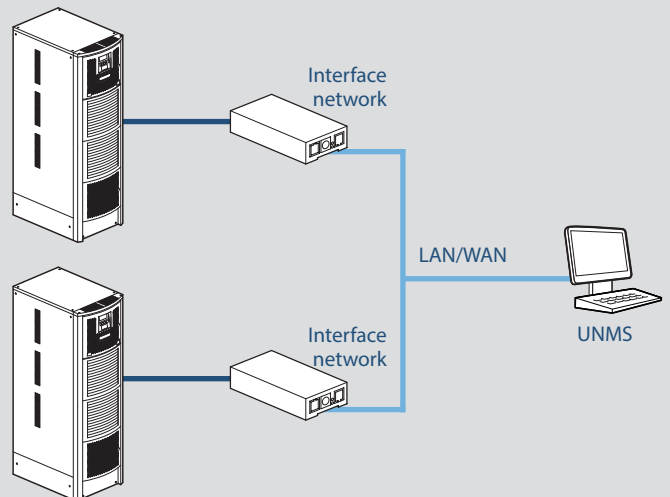

Download the free UPS management software at www.ups.legrand.com

Communication accessories compatibility table

	UPS Communicator	UPS Management Software		CS141 SK	CS141B SK	CS141	CS141B	CS141M	CS141M SK	CS101
	Free	3 108 79	3 108 80	3 109 30	3 109 31	3 109 32	3 109 33	3 109 34	3 109 35	3 109 38
UPS										
Daker DK Plus										
Keor LP										
Keor S 3000										
Keor S 6000 - 10000										
Megaline / Megaline Rack										
Keor T Evo										
Keor HP										
Keor HPE										
Trimod HE										
Keor MOD										
Keor Compact										
Keor XPE										
Software										
RCCMD (all codes)										
UNMS (all codes)										

n Other accessories

	SM_T_COM	SM_T_H_COM	Sensor Manager	SM_T	SM_T_H	Port sensor	SM_Flash
	3 108 97	3 108 98	3 108 99	3 109 00	3 109 01	3 109 02	3 109 03
3 109 30 - CS141 SK	*	*	*				
3 109 32 - CS141	*	*	*				
3 108 99 - Sensor Manager							

* Not for simultaneous use

CUSTOMER SERVICES



Reliable

Directly present in more than 70 countries and servicing its products in more than 150 countries worldwide, a team of qualified engineers is available to support your UPS system to ensure power quality and availability to the most critical loads.

Excellent

Legrand's competitive edge lies in its ability to provide high value-added UPS systems and services for both end users and business partners.

For Legrand, creating value means coming up with solutions for lower energy consumption, but also integrating product design into the overall development process. With around 200 000 catalogue items, the Group also provides all products required for electrical and digital building installations, particularly as integrated systems, finding solutions to fit everyone's needs.

Tailor-made

Legrand offers a complete range of specific solutions and services to meet customer requirements:

- Technical pre-sales support at the project design stage
- Factory acceptance test
- Supervision of installation, testing and commissioning, site acceptance test
- Operator training
- Site audit
- Warranty extension
- Annual maintenance contract
- Fast intervention on emergency call

CUSTOMER SERVICES

SUPPORT



SITE INSPECTION, INSTALLATION SUPERVISION.

We perform a comprehensive check of the UPS environment to ensure safety and fault-free operation. Our technical experts give manufacturer's recommendations to the site engineer or electrical contractors, and supervise the UPS installation before load power-up.

SITE TEST, COMMISSIONING.

Our Service Engineers conduct rigorous site tests and full setting-up of the UPS system before going live. They also perform site acceptance tests according to your requirements. Commissioning operations for all UPS are carried out by qualified engineers to guarantee seamless start-up. After the final handing over of the UPS system, a Test and Commissioning report is delivered to you.

TRAINING



We offer on-site training to ensure your equipment's safe and efficient operation.

Troubleshooting courses are also available in our plants for intensive hands-on practice on UPS training equipment.

MAINTENANCE



PREVENTIVE MAINTENANCE

Electronic equipment and power systems, such as UPS, contain life-limited components and parts that must be replaced according to the manufacturer's specifications. To ensure optimal performance and to protect your critical application from potential downtime, it is crucial to perform

preventive maintenance operations on a regular basis and replace parts when needed. Our Service Contracts include cleaning, IR thermography, measurements, functional tests, event log and power quality analysis, battery health check, hardware and software upgrades, and technical reports. A Preventive Maintenance Plan is one of the most cost-effective actions that can preserve your initial investment and ensure your business continuity.

CORRECTIVE MAINTENANCE, EMERGENCY CALL

In the event of an Emergency Call, our worldwide service network, with engineers and spare-parts stocks strategically located as close as possible to your site, guarantees a fast intervention time with 24/7/365 assistance. After connecting his laptop to your UPS, very powerful diagnostic software helps our engineer to identify the fault, thus ensuring short MTTR (Mean Time To Repair). Corrective actions are performed such as part replacement, adjustments and upgrades to return the UPS system back to normal operation.



Head Office:

Jl. Pantai Indah Selatan
Komplek Pergudangan
Sentra Industri PIK A No. 6
Jakarta Utara 14470 - Indonesia
Telp :(+62) 5081 3081
Fax :(+62) 5081 3091
E-mail:sales.indonesia@legrand.co.id

Bandung:

Jl. Prof. Surya Sumantri Kav 5E Bandung
40152
- Indonesia
Telp :(+62) 200 8979
E-mail: legrand.bandung@legrand.co.id

Surabaya:

Graha Pena Lantai 14, Suite 1407
Jl. A Yani 88 - Surabaya 60234
Telp :(+62-31) 3360 1221
E-mail: legrand.surabaya@legrand.co.id

Medan:

Jl. Thamrin 20B
Medan - Indonesia
Telp :(+62) 451 7396. 451 7431
Fax :(+62) 451 7431
E-mail: legrand.medan@legrand.co.id



FOLLOW US
ALSO ON

@ www.ups.legrand.com
www.legrand.co.id